

User's Guide

HXC cameras – Release 2 (Camera Link®)

Document Version: v1.8
Release: 13.06.2014
Document Number: 11080602

Table of Contents

1. General Information	4
2. General safety instructions	5
3. Intended Use	5
4. General Description	5
5. Camera Models	6
5.1 HXC – Cameras with C-Mount	6
5.2 HXC-F – Cameras with F-Mount	7
6. Product Specifications	8
6.1 Identification of Firmware version	8
6.2 Sensor Specifications	8
6.2.1 Identification of Sensor Version	8
6.2.2 Quantum Efficiency for HXC Cameras	8
6.2.3 Shutter	8
6.2.4 Digitization Taps	9
6.3 Timings	10
6.3.1 Free Running Mode	10
6.3.2 Trigger Mode	11
6.4 Field of View Position	15
6.5 Process- and Data Interface	16
6.5.1 Pin-Assignment CameraLink® Interface	16
6.5.2 Pin-Assignment Power Supply and Digital IOs	17
6.5.3 LED Signaling	17
6.6 Environmental Requirements	18
6.6.1 Temperature and Humidity Range	18
6.6.2 Heat Transmission	18
6.6.3 Mechanical Tests	19
7. Software	20
7.1 GAPI	20
8. Camera Functionalities	21
8.1 Image Acquisition	21
8.1.1 Image Format	21
8.1.2 Pixel Format	22
8.1.3 Exposure Time	24
8.1.4 PRNU / DSNU Correction (FPN - Fixed Pattern Noise)	24
8.1.5 High Dynamic Range (HDR)	25
8.1.6 Look-Up-Table	25
8.1.7 Gamma Correction	26
8.1.8 Region of Interest (ROI) and Multi-ROI	26
8.1.9 Binning / Subsampling	28
8.1.10 Brightness Correction (Binning Correction)	29
8.2 Color Adjustment – White Balance	29
8.2.1 User-specific Color Adjustment	29
8.2.2 One Push White Balance	29

8.3 Analog Controls.....	30
8.3.1 Offset / Black Level.....	30
8.3.2 Gain digital.....	30
8.4 Defect Pixel Correction	31
8.4.1 General information.....	31
8.4.2 Correction Algorithm.....	31
8.4.3 Defectpixellist	31
8.5 Sequencer.....	32
8.5.1 General Information.....	32
8.5.2 Examples.....	33
8.5.3 Capability Characteristics of GAPI Sequencer Module	33
8.5.4 Double Shutter	34
8.6 Process Interface	35
8.6.1 Digital IOs.....	35
8.6.2 Trigger Input / Trigger Delay	37
8.6.3 Trigger Source.....	38
8.6.4 Debouncer.....	39
8.6.5 Flash Signal.....	39
8.6.6 Timer.....	40
8.7 User Sets	41
8.8 Factory Settings	41
9. Camera Link® Interface.....	42
9.1 Channel Link and LVDS Technology.....	42
9.2 Camera Signals	42
9.2.1 Serial Communication	42
9.2.2 Camera Control	43
9.2.3 Video Data.....	43
9.3 CameraLink® Taps.....	44
9.3.1 Tap Configuration	44
9.3.2 Tap Geometry.....	48
10. Lens install.....	50
11. Cleaning	51
12. Transport / Storage	51
13. Disposal	52
14. Warranty Information	52
15. Conformity	53
15.1 CE.....	53
15.2 FCC – Class B Device	53
16. Support.....	54

1. General Information



Read these manual carefully and observe the notes and safety instructions!

Notice

This is the technical documentation for the HXC Series. The Baumer Camera HXC 13 has its own technical documentation!

Thank you for purchasing a camera of the Baumer family. This User's Guide describes how to connect, set up and use the camera.

Keep the User's guide stored in a safe place and transmit them to the eventually following users. Please also note the provided technical data sheet.

Target group for this User's Guide

This User's Guide is aimed at experienced business users, which want to integrate camera(s) into a vision system.

Copyright

Any duplication or reprinting of this documentation, in whole or in part, and the reproduction of the illustrations even in modified form is permitted only with the written approval of Baumer. This document is subject to change without notice.

Classification of the safety instructions

In the User's Guide, the safety instructions are classified as follows:

Notice

Gives helpful notes on operation or other general recommendations.



Caution



Indicates a possibly dangerous situation. If the situation is not avoided, slight or minor injury could result or the device may be damaged.

2. General safety instructions

Observe the the following safety instructions when using the camera to avoid any damage or injuries.

⚠ Caution



A power supply with electrical isolation is required for proper operation of the camera. Otherwise the device may be damaged.

⚠ Caution



Provide adequate dissipation of heat, to ensure that the temperature does not exceed the specified temperature (+65 °C /+149 °F).

The surface of the camera may be hot during operation and immediately after use. Be careful when handling the camera and avoid contact over a longer period.

⚠ Caution



When fixing the Camera Link® cable with too much force the screws might get damaged.

The maximum torque is 2.5 inch lbf [0.3 Nm].

3. Intended Use

The camera is used to capture images that can be transferred over two Camera Link® interfaces to a PC.

Notice

Use the camera only for its intended purpose! For any use that is not described in the technical documentation poses dangers and will void the warranty. The risk has to be borne solely by the unit's owner.

4. General Description

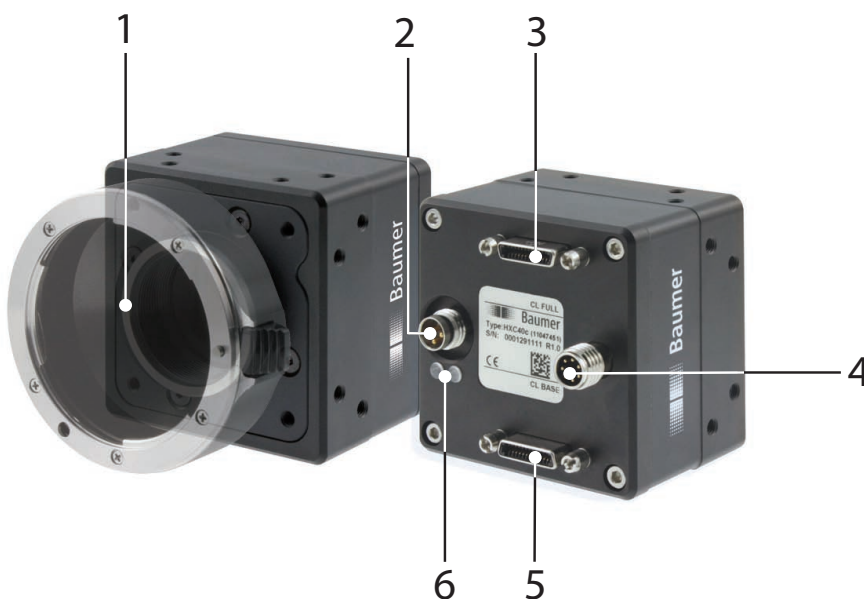

Nr.	Description	Nr.	Description
1	(respective) lens mount	4	Digital-IO supply
2	Power supply	5	Camera Link® Base socket
3	Camera Link® Full socket	6	Signaling-LED

5. Camera Models

5.1 HXC – Cameras with C-Mount



Figure 1 ►

Front and rear view of a Baumer HXC camera with C-Mount

Camera Type	Sensor Size	Resolution	Full Frames [max. fps]
HXC20	2/3"	2048x1088	337
HXC40	1"	2048x2048	180
HXC20c	2/3"	2048x1088	337
HXC40c	1"	2048x2048	180

Dimensions

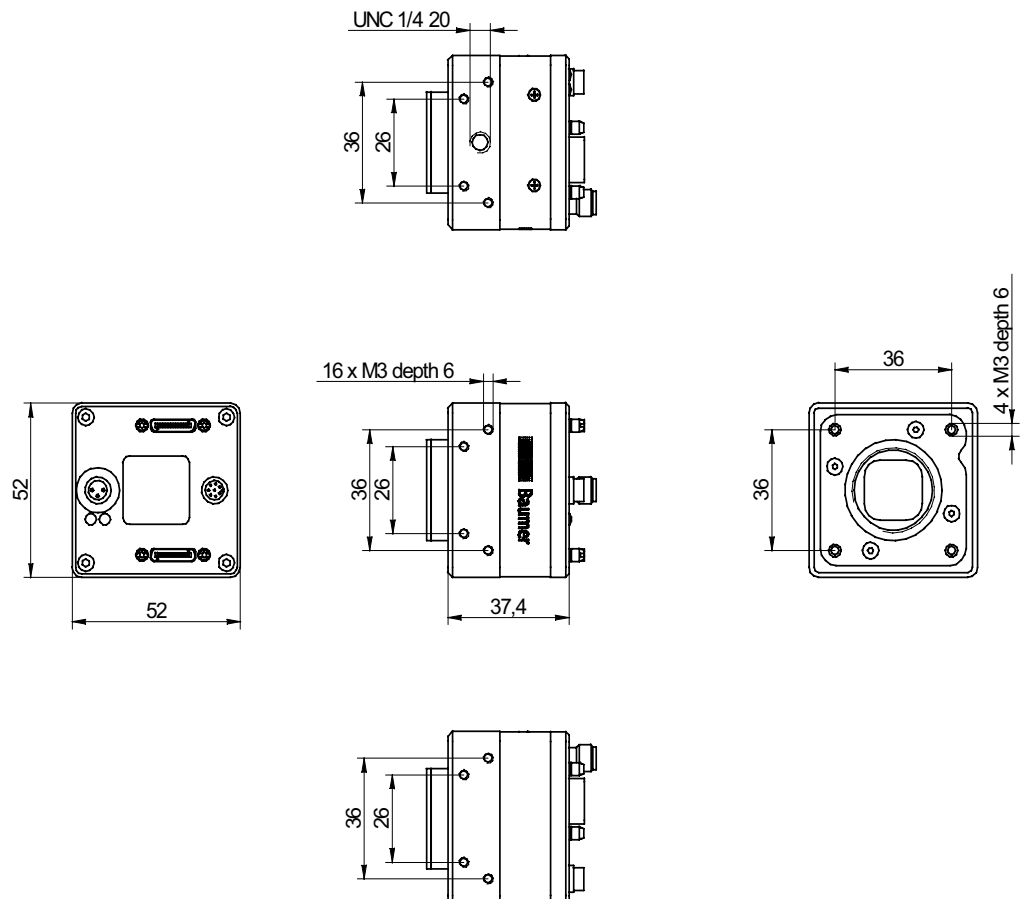

Figure 2 ►

Dimensions of a Baumer HXC camera with C-Mount.

5.2 HXC-F – Cameras with F-Mount



◀ **Figure 3**
Front view of a Baumer HXC camera with F-Mount

Camera Type	Sensor Size	Resolution	Full Frames [max. fps]
HXC20-F	2/3"	2048x1088	337
HXC40-F	1"	2048x2048	180
HXC20c-F	2/3"	2048x1088	337
HXC40c-F	1"	2048x2048	180

Dimensions

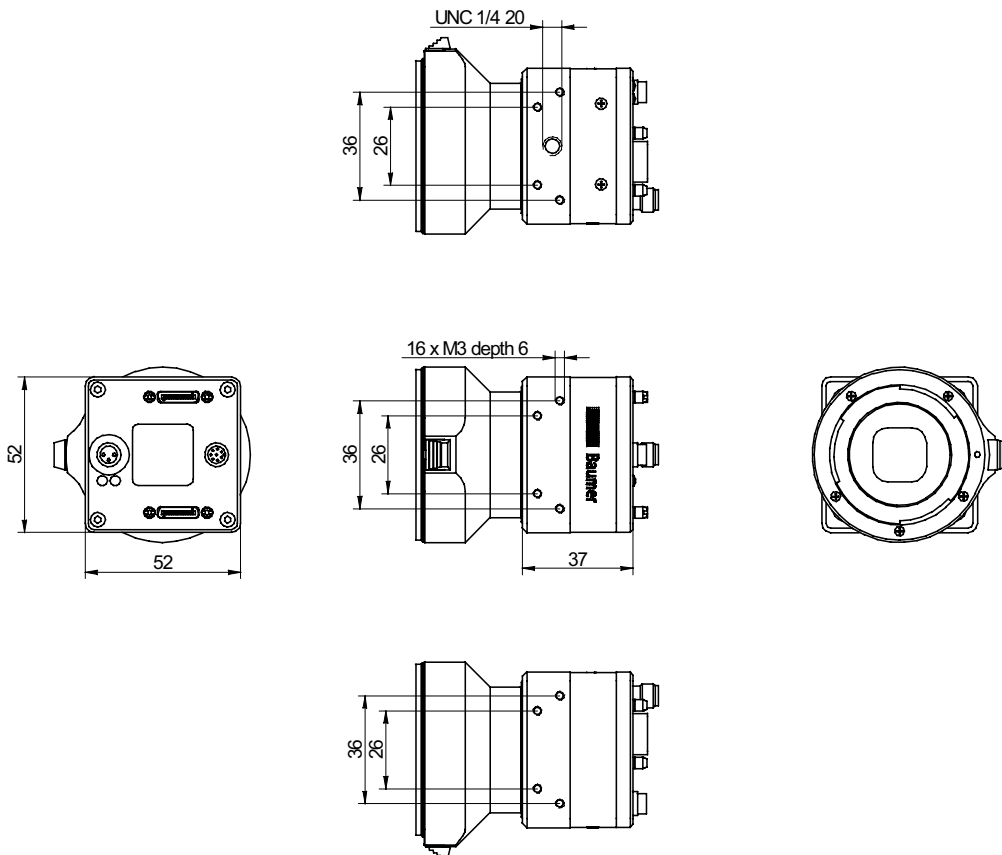

◀ **Figure 4**
Dimensions of a Baumer HXC-F camera.

6. Product Specifications

6.1 Identification of Firmware version

- Label on Camera ("R2.0" is Firmware 2.0)
- BGAPI 1.x - CL Config Tool: *CameraInformation: Hardware Version* (CID Firmware 1.0 starts with 02 / CID Firmware 2.0 starts with 03 (e.g. CID:030004 - Firmware 2.0))
- Read out register $0x00000088$ (see HXC Register Description Release 2)

6.2 Sensor Specifications

6.2.1 Identification of Sensor Version

- Read out register $0xF0004600$ (see HXC Register Description Release 2)

6.2.2 Quantum Efficiency for Baumer HXC Cameras

The quantum efficiency characteristics of monochrome (also in NIR) and color matrix sensors for Baumer HXC cameras are displayed in the following graphs. The characteristic curves for the sensors do not take the characteristics of lenses and light sources without filters into consideration, but are measured with an AR coated cover glass.

Values relating to the respective technical data sheets of the sensors manufacturer.

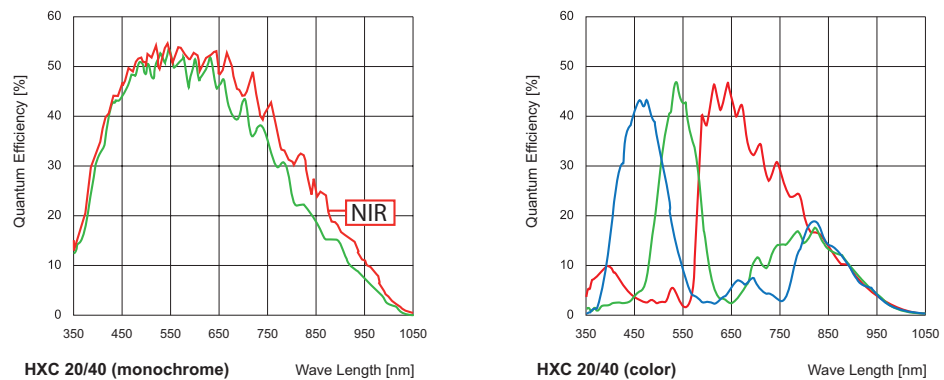

Figure 5 ►

Quantum efficiency for Baumer HXC cameras.

6.2.3 Shutter

All cameras of the HXC series are equipped with a global shutter.

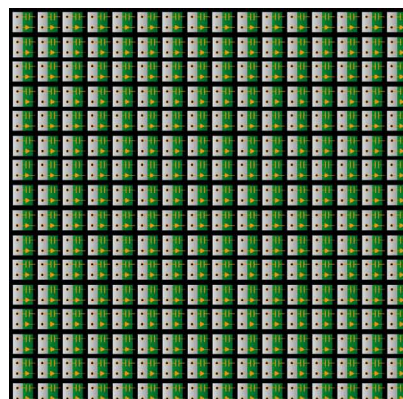
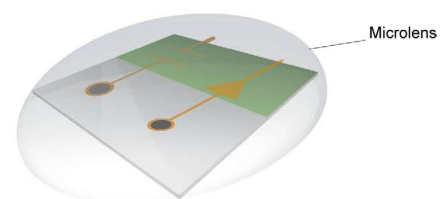

Figure 6 ►

Structure of an imaging sensor with global shutter



- Pixel
- Active Area (Photodiode)
- Storage Area

Global shutter means that all pixels of the sensor are reset and afterwards exposed for a specified interval (t_{exposure}).

For each pixel an adjacent storage circuit exists. Once the exposure time elapsed, the information of a pixel is transferred immediately to its circuit and read out from there.

Due to the fact that photosensitive area gets "lost" by the implementation of the circuit area, the pixels are equipped with microlenses, which focus the light on the pixel.

6.2.4 Digitization Taps

The Truesense sensors, employed in Baumer HXC cameras can be read out up to 16 channels in parallel.

Notice

More channels increase the speed (framerate), but the use of more channels produces a higher heat generation. Use only the maximum required number of channels!

Notice

Due to sensor characteristics in 12 bit mode only 2 or 4 channels are available.

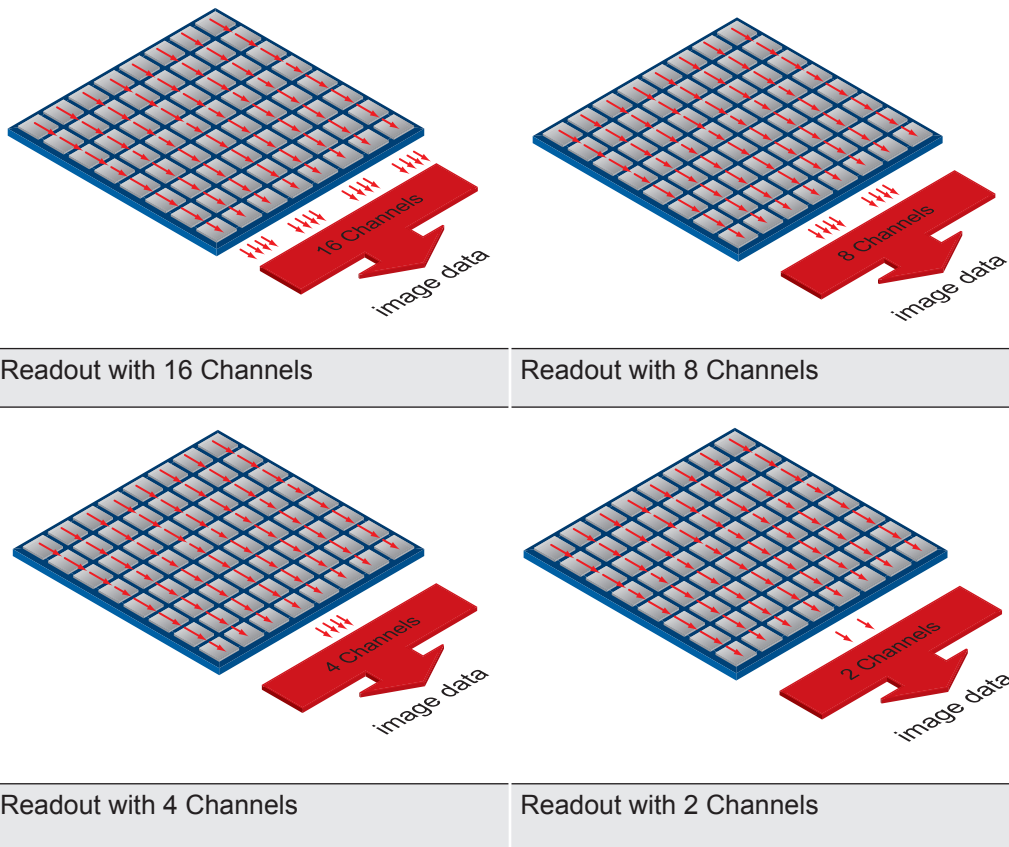

◀ **Figure 7**
Digitization Tap of the
Baumer HXC Cameras

6.3 Timings

Notice

Overlapped mode can be switched off with setting the readout mode to *sequential shutter* instead of *overlapped shutter*.

The image acquisition consists of two separate, successively processed components.

Exposing the pixels on the photosensitive surface of the sensor is only the first part of the image acquisition. After completion of the first step, the pixels are read out.

The exposure time (t_{exposure}) can be adjusted by the user, however, the time needed for the readout (t_{readout}) is given by the particular sensor, image format and configuration.

Baumer HXC cameras can be operated with two modes, the Free Running Mode and the Trigger Mode.

The cameras can be operated non-overlapped*) or overlapped. Depending on the mode used, and the combination of exposure and readout time:

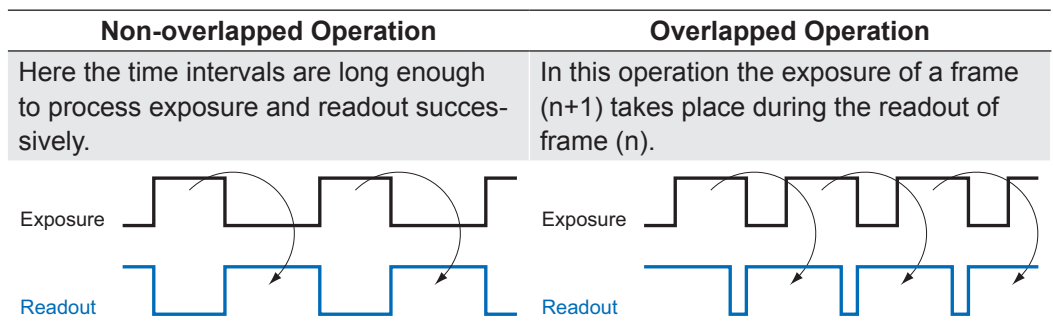

6.3.1 Free Running Mode

In the "Free Running" mode the camera records images permanently and sends them to the PC. In order to achieve an optimal (with regard to the adjusted exposure time t_{exposure} and image format) the camera is operated overlapped.

In case of exposure times equal to / less than the readout time ($t_{\text{exposure}} \leq t_{\text{readout}}$), the maximum frame rate is provided for the image format used. This is for overlapped mode. For longer exposure times the frame rate of the camera is reduced. This is for sequential mode.

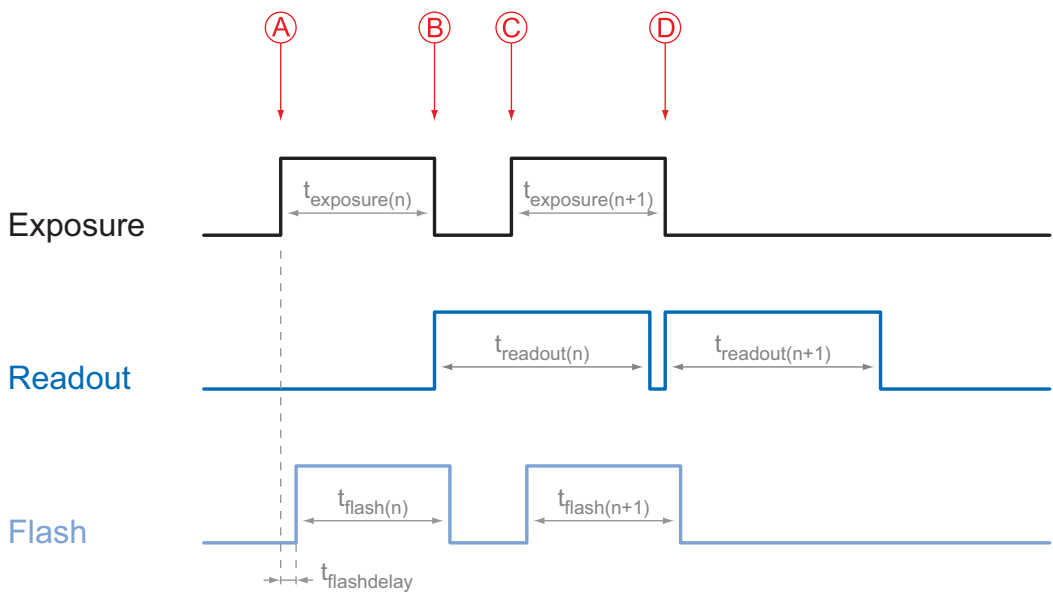

$$t_{\text{flash}} = t_{\text{exposure}}$$

Timings:
A - exposure time frame (n) effective
B - image parameters frame (n) effective
C - exposure time frame (n+1) effective
D - image parameters frame (n+1) effective

Image parameters:
Offset
Gain
Mode
Partial Scan

*) Non-overlapped means the same as sequential.

6.3.2 Trigger Mode

After a specified external event (trigger) has occurred, image acquisition is started. Depending on the interval of triggers used, the camera may operate non-overlapped or overlapped in this mode, when overlapped mode is enabled.

With regard to timings in the trigger mode, the following basic formulas need to be taken into consideration:

Case	Formula
$t_{\text{exposure}} < t_{\text{readout}}$	(1) $t_{\text{earliestpossibletrigger}(n+1)} = t_{\text{readout}(n)} - t_{\text{exposure}(n+1)}$
	(2) $t_{\text{notready}(n+1)} = t_{\text{exposure}(n)} + t_{\text{readout}(n)} - t_{\text{exposure}(n+1)}$
$t_{\text{exposure}} > t_{\text{readout}}$	(3) $t_{\text{earliestpossibletrigger}(n+1)} = t_{\text{exposure}(n)}$
	(4) $t_{\text{notready}(n+1)} = t_{\text{exposure}(n)}$

6.3.2.1 Overlapped Operation: $t_{\text{exposure}(n+2)} = t_{\text{exposure}(n+1)}$

In overlapped operation attention should be paid to the time interval where the camera is unable to process occurring trigger signals (t_{notready}). This interval is situated between two exposures. When this process time t_{notready} has elapsed, the camera is able to react to external events again.

After t_{notready} has elapsed, the timing of (E) depends on the readout time of the current image ($t_{\text{readout}(n)}$) and exposure time of the next image ($t_{\text{exposure}(n+1)}$). It can be determined by the formulas mentioned above (no. 1 or 3, as is the case).

In case of identical exposure times, t_{notready} remains the same from acquisition to acquisition.

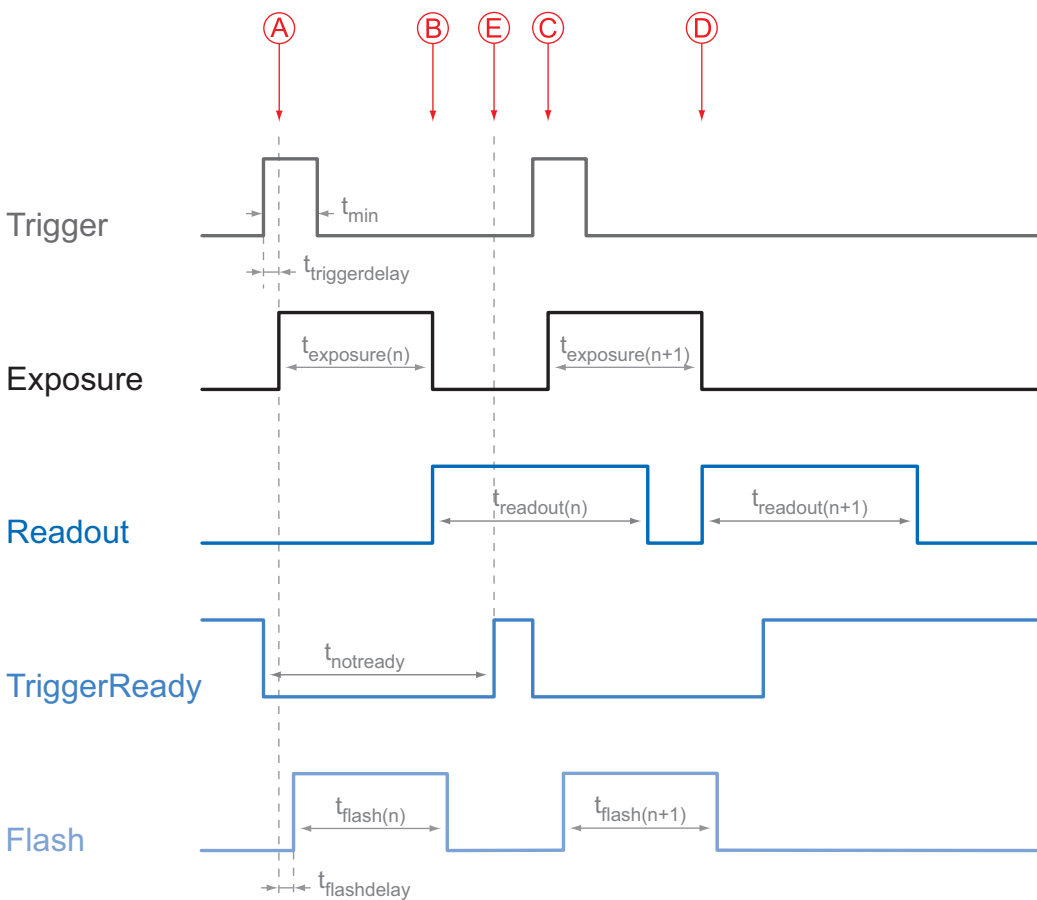

Timings:
A - exposure time frame (n) effective
B - image parameters frame (n) effective
C - exposure time frame (n+1) effective
D - image parameters frame (n+1) effective
E - earliest possible trigger

Image parameters:
Offset
Gain
Mode
Partial Scan

6.3.2.2 Overlapped Operation: $t_{\text{exposure}(n+2)} > t_{\text{exposure}(n+1)}$

If the exposure time (t_{exposure}) is increased from the current acquisition to the next acquisition, the time the camera is unable to process occurring trigger signals (t_{notready}) is scaled down.

This can be simulated with the formulas mentioned above (no. 2 or 4, as is the case).

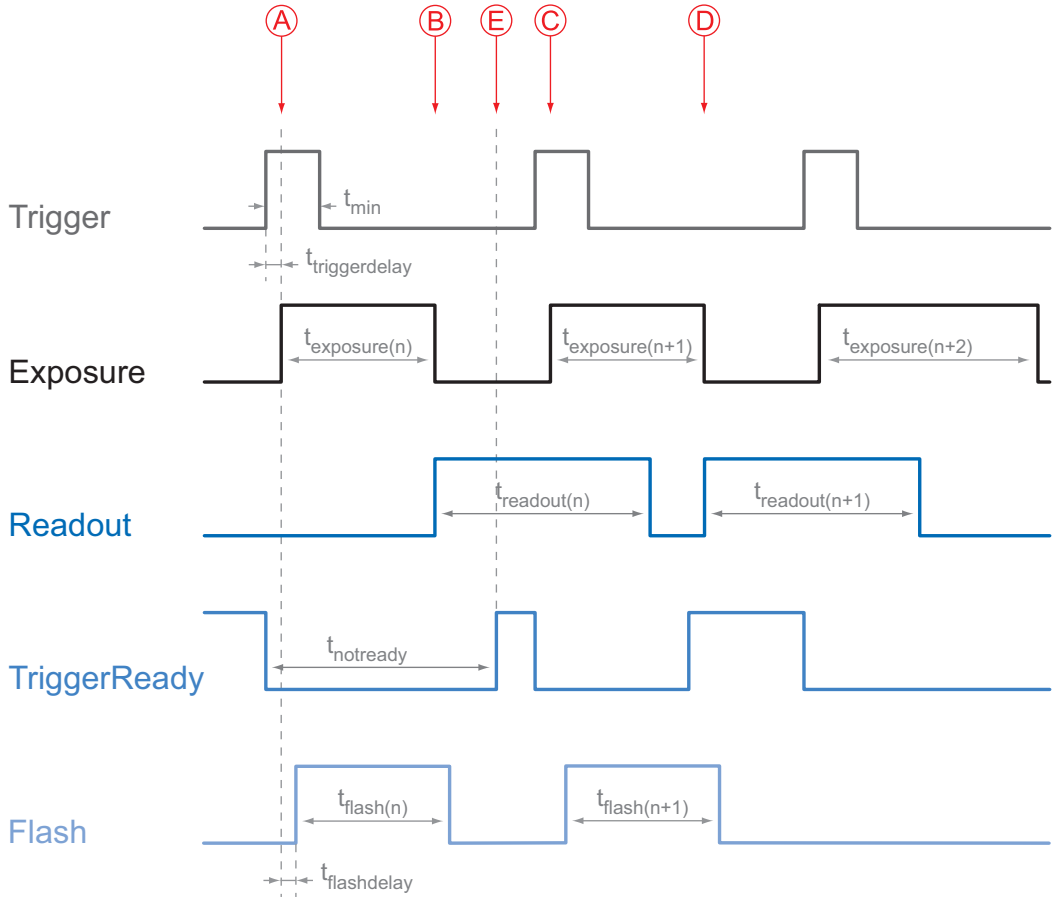

Timings:
A - exposure time frame (n) effective
B - image parameters frame (n) effective
C - exposure time frame (n+1) effective
D - image parameters frame (n+1) effective
E - earliest possible trigger

Image parameters:
Offset
Gain
Mode
Partial Scan

6.3.2.3 Overlapped Operation: $t_{\text{exposure}(n+2)} < t_{\text{exposure}(n+1)}$

If the exposure time (t_{exposure}) is decreased from the current acquisition to the next acquisition, the time the camera is unable to process occurring trigger signals (t_{notready}) is scaled up.

When decreasing the t_{exposure} such, that t_{notready} exceeds the pause between two incoming trigger signals, the camera is unable to process this trigger and the acquisition of the image will not start (the trigger will be skipped).

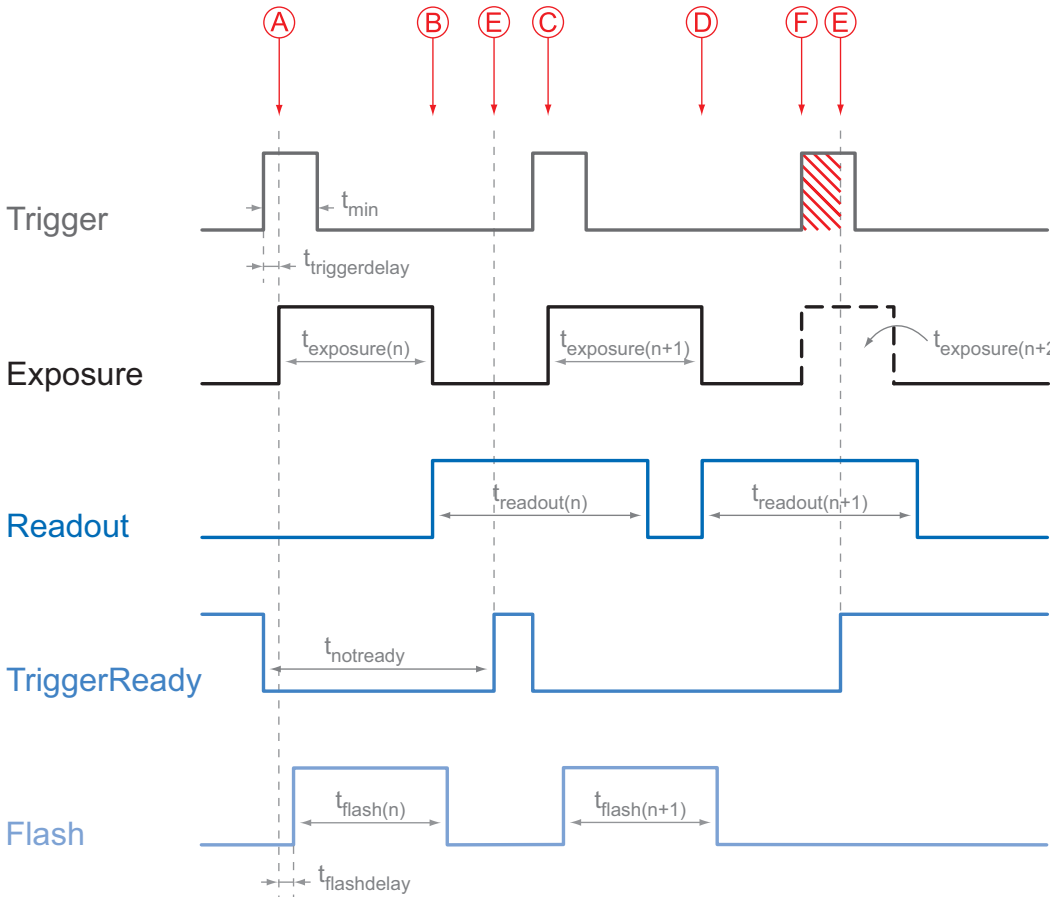

Timings:
A - exposure time frame (n) effective
B - image parameters frame (n) effective
C - exposure time frame (n+1) effective
D - image parameters frame (n+1) effective
E - earliest possible trigger
F - frame not started / trigger skipped

Image parameters:
Offset
Gain
Mode
Partial Scan

Notice
 From a certain frequency of the trigger signal, skipping triggers is unavoidable. In general, this frequency depends on the combination of exposure and readout times and shutter mode.

6.3.2.4 Non-overlapped Operation

If the period between two trigger pulses is long enough, so that the image acquisitions ($t_{\text{exposure}} + t_{\text{readout}}$) run successively, the camera operates non-overlapped. In the following figure is the shutter mode set to non-overlapped.

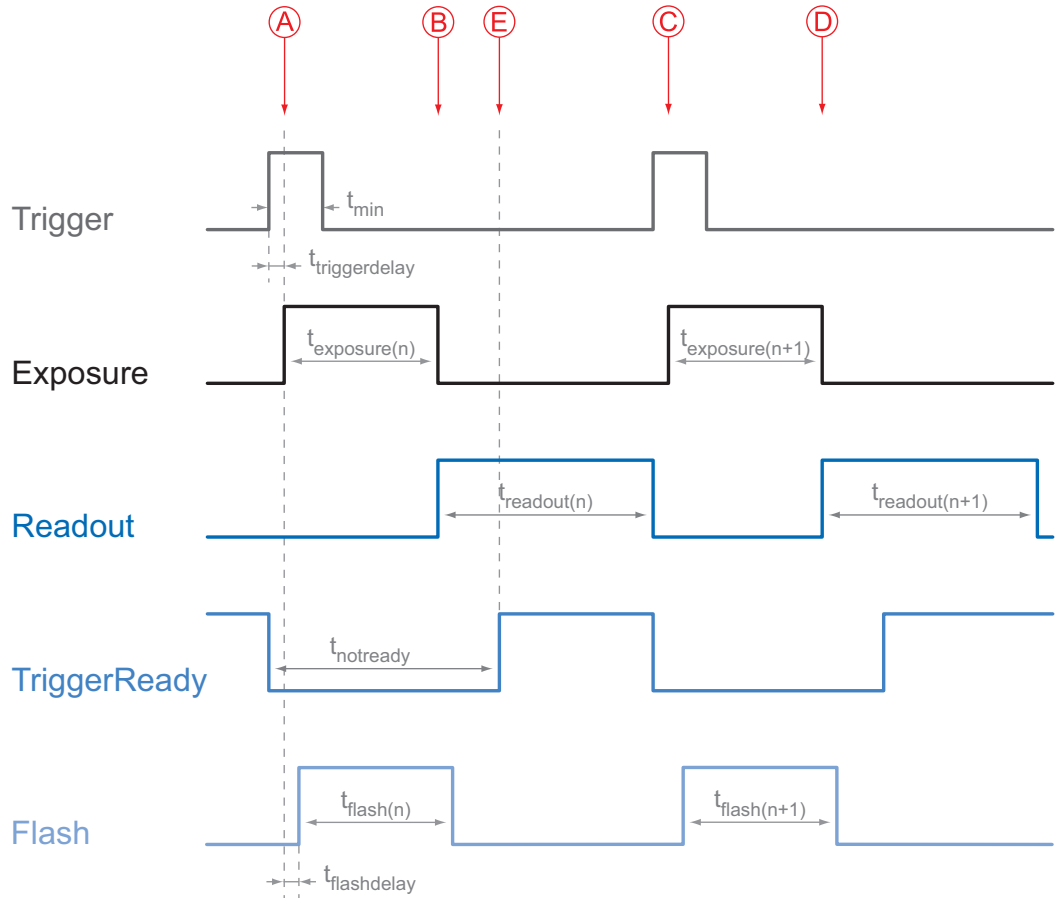

Timings:

- A - exposure time frame (n) effective
- B - image parameters frame (n) effective
- C - exposure time frame (n+1) effective
- D - image parameters frame (n+1) effective
- E - earliest possible trigger

Image parameters:

- Offset
- Gain
- Mode
- Partial Scan

6.4 Field of View Position

The typical accuracy by assumption of the root mean square value is displayed in the figures and the table below:

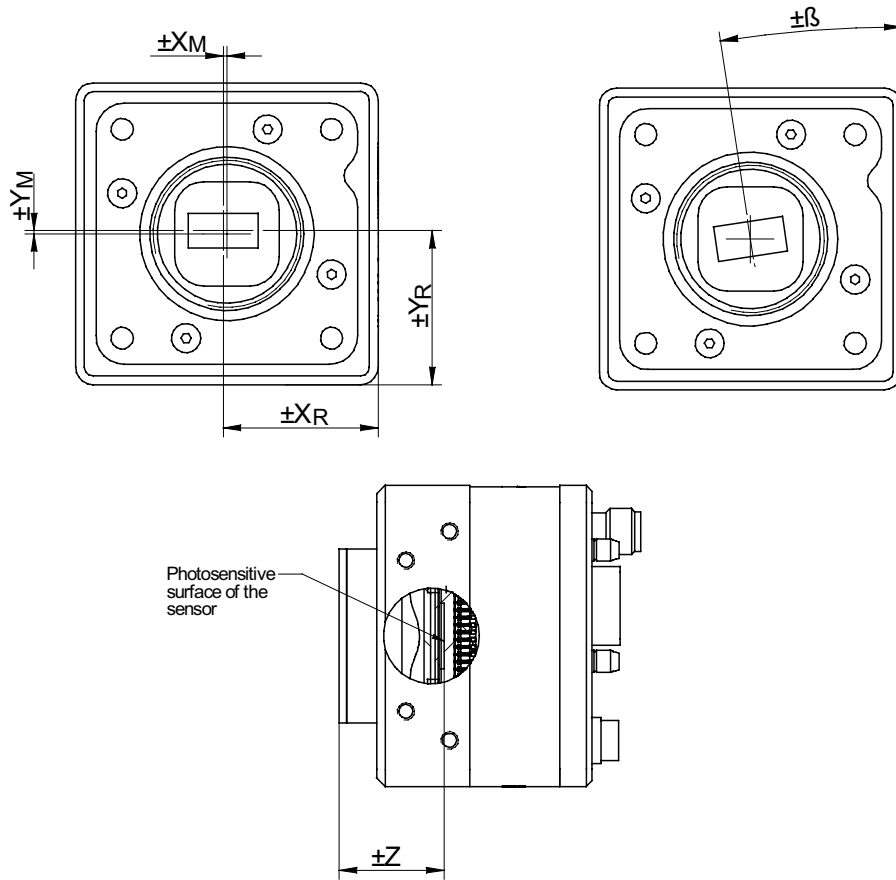

◀ **Figure 8**
Sensor accuracy of
Baumer HXC cameras.

Camera Type	$\pm x_{M,typ}$ [mm]	$\pm y_{M,typ}$ [mm]	$\pm x_{R,typ}$ [mm]	$\pm y_{R,typ}$ [mm]	$\pm \beta_{typ}$ [°]	$\pm z_{typ}$ [mm]
HXC20	0,18	0,18	0,14	0,14	1,2	0,025
HXC40	0,18	0,18	0,14	0,14	1,2	0,025

6.5 Process- and Data Interface

6.5.1 Pin-Assignment Camera Link® Interface

Notice

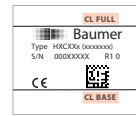

The camera has two Camera Link sockets. To differentiate between Camera Link Base and CamerLink Full socket, please look at the label.

You can not use the CL Full socket alone!



Caution



When fixing the Camera Link® cable with too much force the screws might get damaged.

The maximum torque is 2.5 inch lbf [0.3 Nm].

Date / Camera Link® Full

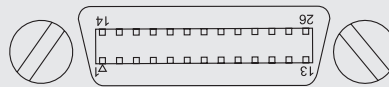

1	GND	10	Z2-	19	Y3+
2	Y0-	11	ZCLK-	20	100 Ω Term.
3	Y1-	12	Z3-	21	Z0+
4	Y2-	13	GND	22	Z1+
5	YCLK-	14	GND	23	Z2+
6	Y3-	15	Y0+	24	ZCLK+
7	100 Ω Term.	16	Y1+	25	Z3+
8	Z0-	17	Y2+	26	GND
9	Z1-	18	YCLK+		

Data / Control / Camera Link® Base



1	GND	10	CC2+	19	X3+
2	X0-	11	CC3-	20	SERTC-
3	X1-	12	CC4+	21	SERTFG+
4	X2-	13	GND	22	CC1+
5	XCLK-	14	GND	23	CC2-
6	X3-	15	X0+	24	CC3+
7	SERTC+	16	X1+	25	CC4-
8	SERTFG-	17	X2+	26	GND
9	CC1-	18	XCLK+		

6.5.2 Pin-Assignment Power Supply and Digital IOs

⚠ Caution



A power supply with electrical isolation is required for proper operation of the camera. Otherwise the device may be damaged.

M8 / 3 pins			M8 / 8 pins		
1	(brown)	Power V_{CC}	1	(white)	Line 9
3	(blue)	GND	2	(brown)	Line 1
4	(black)	not used	3	(green)	Line 0
			4	(yellow)	GND
			5	(grey)	U_{ext}
			6	(pink)	Line 7
			7	(blue)	Line 8
			8	(red)	Line 2

Power Supply

Power VCC	9,6 VDC ... 30 VDC
I	Mono8, Camera Link base, dual tap, 40 MHz; 190 mA .. 550 mA Mono8, Camera Link full, 10 tap, 48 MHz; 200 mA .. 620 mA
Power consumption	approx. 5.5 Watt (with camera factory settings)

6.5.3 LED Signaling

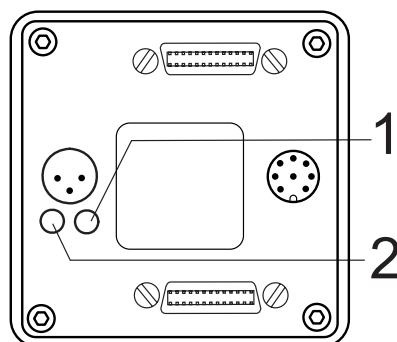

LED	Signal	Meaning
1	green	Transmitting
	red (yellow in both)	Configuration command processing
2	green	Power on
	yellow	Readout active

6.6 Environmental Requirements

6.6.1 Temperature and Humidity Range¹⁾

Temperature	
Storage temperature	
HXC20	-10 °C ... +70 °C (+14 °F ... +158 °F)
HXC40	-10 °C ... +70 °C (+14 °F ... +158 °F)
Operating temperature*	
HXC20	+5 °C ... +60 °C (+41 °F ... +140 °F)
HXC40	+5 °C ... +60 °C (+41 °F ... +140 °F)
Housing operating temperature ^{**} ***)	
HXC20	max. +65 °C (+149 °F)
HXC40	max. +65 °C (+149 °F)
Internal operating temperature	
HXC20	max. +60 °C (+140 °F)
HXC40	max. +60 °C (+140 °F)

Humidity	
Storage and Operating Humidity	10% ... 90% Non-condensing

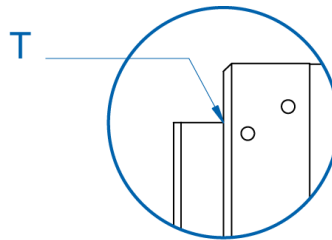



Figure 9 ►

Temperature measurement points of Baumer HXC cameras.

6.6.2 Heat Transmission

⚠ Caution	
	Provide adequate dissipation of heat, to ensure that the temperature does not exceed the specified temperature (+65°C /+149°F).
	The surface of the camera may be hot during operation and immediately after use. Be careful when handling the camera and avoid contact over a longer period.

It is very important to provide adequate dissipation of heat, to ensure that the housing temperature does not reach or exceed +65°C (+149°F). As there are numerous possibilities for installation, Baumer do not specify a specific method for proper heat dissipation, but suggest the following principles:

- operate the cameras only in mounted condition
- mounting in combination with forced convection may provide proper heat dissipation

*) Please refer to the respective data sheet.

**) Measured at temperature measurement point (T).

***) Housing temperature is limited by sensor specifications.

6.6.3 Mechanical Tests

Environmental Testing	Standard	Parameter	
Vibration, sinusoidal	IEC 60068-2-6	Search for Resonance	10-2000 Hz
		Amplitude underneath crossover frequencies	1.5 mm
		Acceleration	1 g
		Test duration	15 min
Vibration, broad band	IEC 60068-2-64	Frequency range	20-1000 Hz
		Acceleration	10 g
		Displacement	5.7 mm
		Test duration	300 min
Shock	IEC 60068-2-27	Puls time	11 ms / 6 ms
		Acceleration	50 g / 100 g
Bump	IEC60068-2-29	Pulse Time	2 ms
		Acceleration	80 g

7. Software

7.1 Baumer GAPI

Baumer GAPI stands for **Baumer “Generic Application Programming Interface”**. With this API Baumer provides an interface for optimal integration and control of Baumer cameras. This software interface allows changing to other camera models.

It provides interfaces to several programming languages, such as C, C++ and the .NET™ Framework on Windows®, as well as Mono on Linux® operating systems, which offers the use of other languages, such as e.g. C# or VB.NET.

The HXC camera features are in general supported by Baumer GAPI v 1.7.2. However, to use the new release 2 features (e.g. HDR and Multi-ROI) Baumer GAPI v 2.1 is required.

Notice

There is currently no Baumer GAPI version for Linux available with support for Camera Link®.

Notice

Please note the extra instructions to the software Baumer GAPI. Specifically for Camera Link® Cameras, the "User's Guide CLConfig Tool".

8. Camera Functionalities

8.1 Image Acquisition

8.1.1 Image Format

A digital camera usually delivers image data in at least one format - the native resolution of the sensor. Baumer cameras are able to provide several image formats (depending on the type of camera).

Compared with standard cameras, the image format on Baumer cameras not only includes resolution, but a set of predefined parameter.

These parameters are:

- Resolution (horizontal and vertical dimensions in pixels)
- Binning Mode (combining of neighboring pixels)
- Subsampling (not every pixel is read)

Camera Type	Full frame	Binning 2x1	Subsampling 2x2
HXC20	■	■	■
HXC40	■	■	■
HXC20c	■	□	□
HXC40c	■	□	□

8.1.2 Pixel Format

On Baumer digital cameras the pixel format depends on the selected image format.

8.1.2.1 Pixel Formats on Baumer HXC Cameras

Camera Type	Mono 8	Mono 10	Mono 12	BayerRG8	BayerRG10	BayerRG12
Mono						
HXC20	■	■	■	□	□	□
HXC40	■	■	■	□	□	□
Color						
HXC20c	□	□	□	■	■	■
HXC40c	□	□	□	■	■	■

8.1.2.2 Definitions

Below is a general description of pixel formats. The table above shows, which camera supports which format.

RAW: Raw data format. Here the data are stored without processing.

Bayer: Raw data format of color sensors.
Color filters are placed on these sensors in a checkerboard pattern, generally in a 50% green, 25% red and 25% blue array.

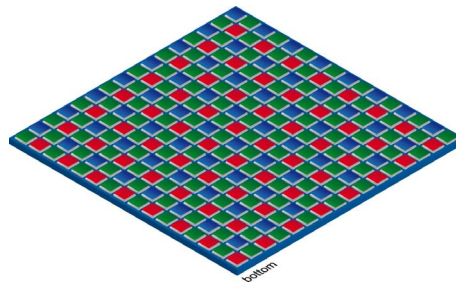
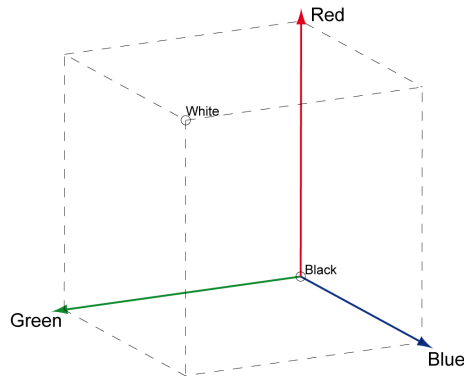

Figure 10 ▶

Sensor with Bayer Pattern.

Mono: Monochrome. The color range of mono images consists of shades of a single color. In general, shades of gray or black-and-white are synonyms for monochrome.

RGB: Color model, in which all detectable colors are defined by three coordinates, Red, Green and Blue.



◀ **Figure 11**
RGB color space displayed as color tube.

The three coordinates are displayed within the buffer in the order R, G, B.

BGR: Here the color alignment mirrors RGB.

YUV: Color model, which is used in the PAL TV standard and in image compression. In YUV, a high bandwidth luminance signal (Y: luma information) is transmitted together with two color difference signals with low bandwidth (U and V: chroma information). Thereby U represents the difference between blue and luminance ($U = B - Y$), V is the difference between red and luminance ($V = R - Y$). The third color, green, does not need to be transmitted, its value can be calculated from the other three values.

YUV 4:4:4 Here each of the three components has the same sample rate. Therefore there is no subsampling here.

YUV 4:2:2 The chroma components are sampled at half the sample rate. This reduces the necessary bandwidth to two-thirds (in relation to 4:4:4) and causes no, or low visual differences.

YUV 4:1:1 Here the chroma components are sampled at a quarter of the sample rate. This decreases the necessary bandwidth by half (in relation to 4:4:4).

Pixel depth: In general, pixel depth defines the number of possible different values for each color channel. Mostly this will be 8 bit, which means 2^8 different "colors".

For RGB or BGR these 8 bits per channel equal 24 bits overall.

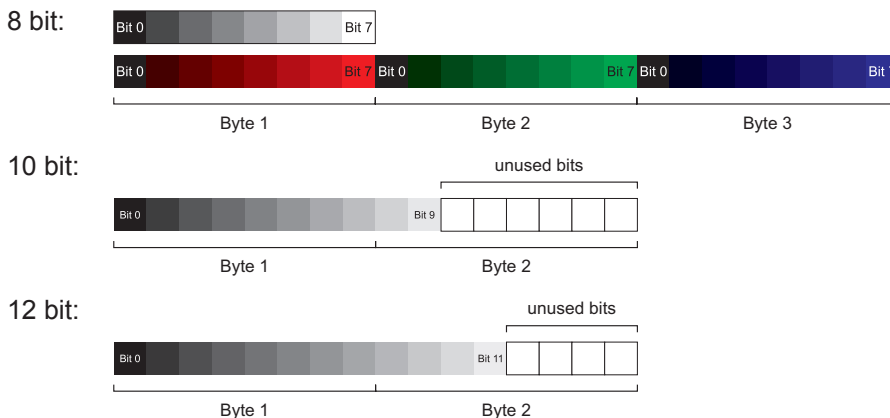

◀ **Figure 12**
Bit string of Mono 8 bit and RGB 8 bit.

◀ **Figure 13**
Spreading of Mono 10 bit over 2 bytes.

◀ **Figure 14**
Spreading of Mono 12 bit over two bytes.

8.1.3 Exposure Time

On exposure of the sensor, the inclination of photons produces a charge separation on the semiconductors of the pixels. This results in a voltage difference, which is used for signal extraction.

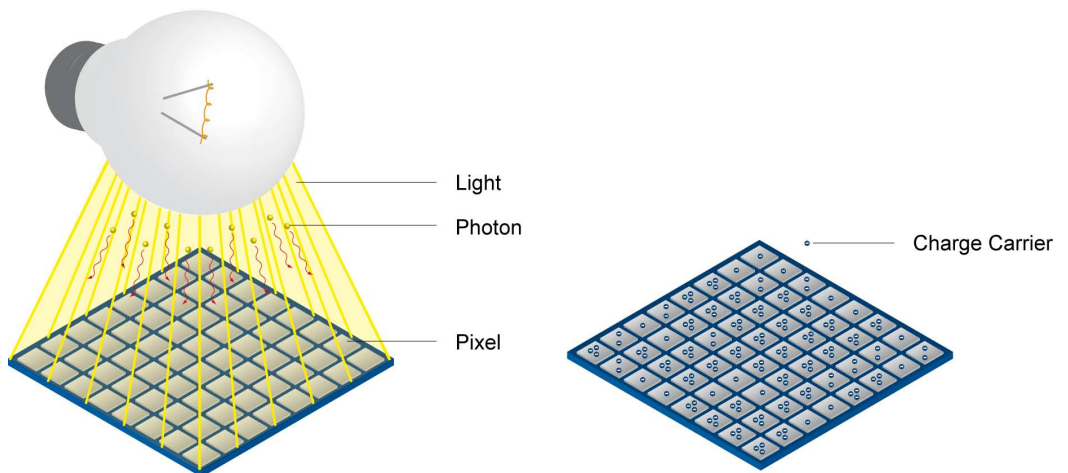

Figure 15 ▶

Incidence of light causes charge separation on the semiconductors of the sensor.

The signal strength is influenced by the incoming amount of photons. It can be increased by increasing the exposure time (t_{exposure}).

On Baumer HXC cameras, the exposure time can be set within the following ranges (step size 1µsec):

Camera Type	t_{exposure} min	t_{exposure} max
HXC20 / HXC20c	4 µsec	1 sec
HXC40 / HXC40c	4 µsec	1 sec

8.1.4 PRNU / DSNU Correction (FPN - Fixed Pattern Noise)

CMOS sensors exhibit nonuniformities that are often called fixed pattern noise (FPN). However it is no noise but a fixed variation from pixel to pixel that can be corrected. The advantage of using this correction is a more homogeneous picture which may simplify the image analysis. Variations from pixel to pixel of the dark signal are called dark signal non-uniformity (DSNU) whereas photo response nonuniformity (PRNU) describes variations of the sensitivity. DNSU is corrected via an offset while PRNU is corrected by a factor.

The correction is based on columns. It is important that the correction values are computed for the used sensor readout configuration. During camera production this is derived for the factory defaults. If other settings are used (e.g. different number of readout channels) using this correction with the default data set may degrade the image quality. In this case the user may derive a specific data set for the used setup.



PRNU / DSNU Correction Off

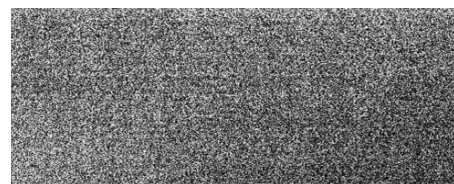

PRNU / DSNU Correction On

8.1.5 High Dynamic Range (HDR)

Beside the standard linear response the sensor supports a special high dynamic range mode (HDR) called piecewise linear response. With this mode illuminated pixels that reach a certain programmable voltage level will be clipped. Darker pixels that do not reach this threshold remain unchanged. The clipping can be adjusted two times within a single exposure by configuring the respective time slices and clipping voltage levels. See the figure below for details.

In this mode, the values for t_{Exp0} , t_{Exp1} , Pot_0 and Pot_1 can be edited.

The value for t_{Exp2} will be calculated automatically in the camera. ($t_{Exp2} = t_{exposure} - t_{Exp0} - t_{Exp1}$)

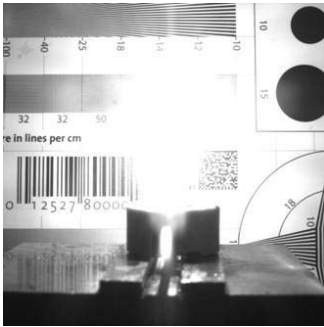

HDR Off

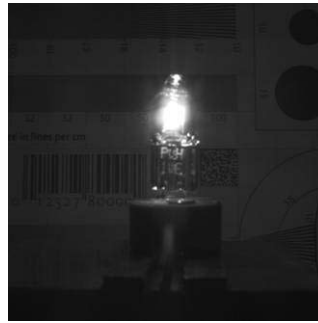

HDR On

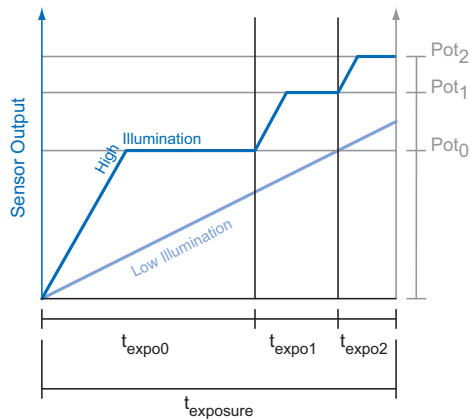

8.1.6 Look-Up-Table

The Look-Up-Table (LUT) can only be used at monochrome cameras. It contains 2^{12} (4096) values for the available levels of gray. These values can be adjusted by the user.

Notice

The LUT always calculates with 12 bit input and 12 bit output. In 8/10 bit mode, the lower bits of the input values are equal zero but can be spread to full 12 bit because of digital gain. Therefore, all values of the LUT have to be filled in.

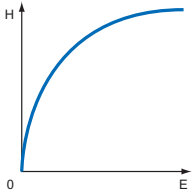

▲ **Figure 16**

Non-linear perception of the human eye.

H - Perception of brightness

E - Energy of light

8.1.7 Gamma Correction

With this feature, Baumer HXC cameras offer the possibility of compensating nonlinearity in the perception of light by the human eye.

For this correction, the corrected pixel intensity (Y') is calculated from the original intensity of the sensor's pixel (Y_{original}) and correction factor γ using the following formula (in oversimplified version):

$$Y' = Y_{\text{original}}^{\gamma}$$

8.1.8 Region of Interest (ROI) and Multi-ROI

With this functions it is possible to predefine a so-called Region of Interest (ROI) or Partial Scan. The ROI is an area of pixels of the sensor. After image acquisition, only the information of these pixels is sent to the PC.

This functions is turned on, when only a region of the field of view is of interest. It is coupled to a reduction in resolution and increases the frame rate.

The ROI is specified by following values:

- Region Selector Region 0 / Multi-ROI horizontal 1-8, Multi-ROI vertical 1-8
- Region Mode On/Off
- Offset X - x-coordinate of the first relevant pixel
- Offset Y - y-coordinate of the first relevant pixel
- Width - horizontal size of the ROI
- Height - vertical size of the ROI

Notice

The values of the Offset X and Size X must be a multiple of 32!

The step size in Y direction is 1 pixel at monochrome cameras and 2 pixel at color cameras.

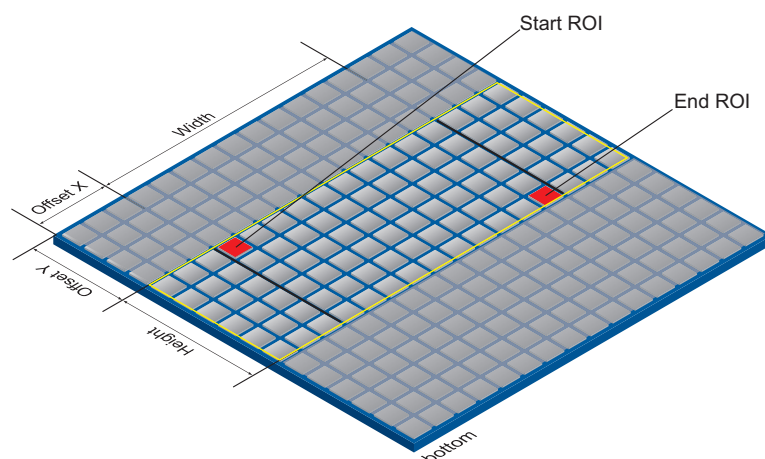

Figure 17 ▶

Parameters of the ROI.

8.1.8.1 Normal-ROI Readout (Region 0)

For the sensor readout time of the ROI, the horizontal subdivision of the sensor is unimportant – only the vertical subdivision is of importance.

The activation of ROI turns off all Multi-ROIs.

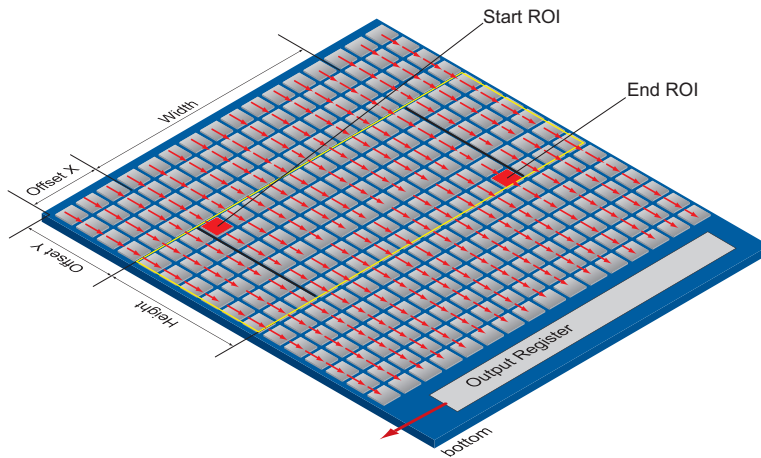

◀ **Figure 18**
ROI: Readout

The readout of the sensor is line based, which means always a complete line of pixels needs to be read out and afterwards the irrelevant information is discarded.

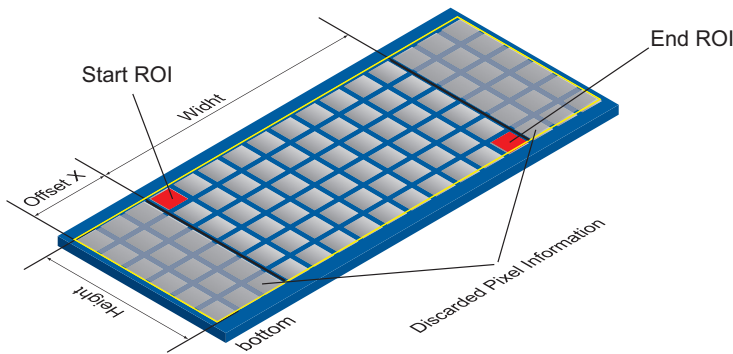

◀ **Figure 19**
ROI:
Discarded Information

8.1.8.2 Multi-ROI

With Multi-ROI it is possible to predefine several Region of Interests (ROIs). It can be specified up to 8 horizontal and vertical stripes (total up to 64 ROIs). Overlapped Multi-ROIs will be merged by the camera. The Multi-ROI's are sorted by the camera.

The camera only reads out sensor parts that are within one of the active Multi Regions. The readout time is therefore only determined by the Multi Horizontal Regions.

The activation of Multi-ROI turns off ROI.

Notice

Multi-ROI can not be used simultaneously with Binning and Subsampling.

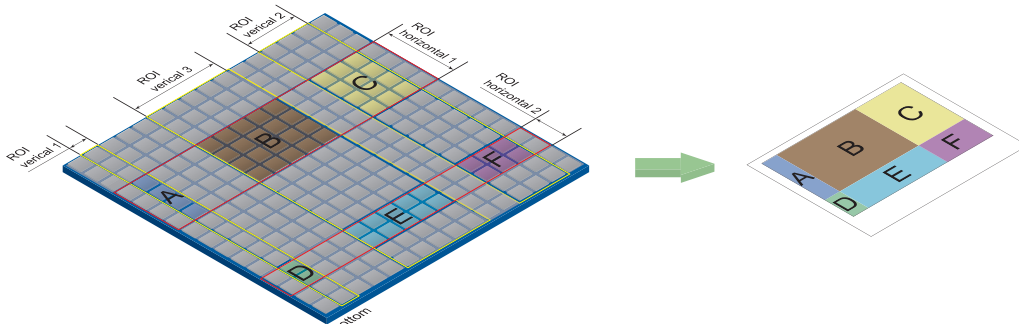

◀ **Figure 20**
Result image generated by using the 5 Multi-ROI's (2x horizontal, 3x vertical)

8.1.9 Binning / Subsampling

Notice

Binning and Subsampling are only available at monochrome cameras.

Baumer HXC cameras support horizontal Binning.

In binning, horizontally neighboring pixels are aggregated and reported to the software as one single "superpixel".

When subsampling, only certain pixels are read out. (Subsampling 2x2 = every second pixel in every second line.)







Binning	Illustration	Example
without		
2x1		
Subsampling 2x2		

Figure 21 ►

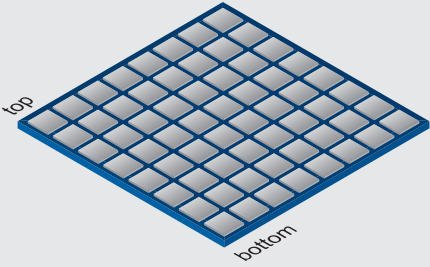
Full frame image, no binning of pixels.

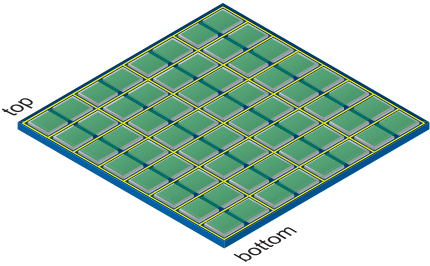
Figure 22 ►

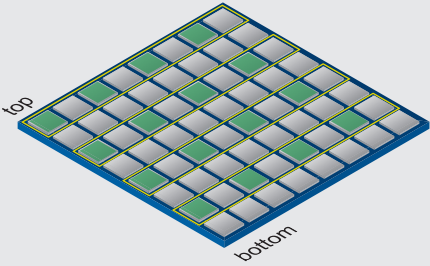
Horizontal binning causes a horizontally compressed image with doubled brightness.

Figure 23 ►

Subsampling 2x2 causes both a horizontally and vertically compressed image

8.1.10 Brightness Correction (Binning Correction)

The summation of pixel values may cause an overload. To prevent this, binning correction was introduced.

Binning	Realization
2x1	2x1 binning takes place within the FPGA of the camera. The binning correction is realized by averaging the pixel values instead of simply adding them.

8.2 Color Adjustment – White Balance

This feature is available on all color cameras of the Baumer HXC series.

White balance means independent adjustment of the three color channels, red, green and blue by employing of a correction factor for each channel.

8.2.1 User-specific Color Adjustment

The user-specific color adjustment in Baumer color cameras facilitates adjustment of the correction factors for each color gain. This way, the user is able to adjust the amplification of each color channel exactly to his needs. The correction factors for the color gains range from 1.0 to 4.0.

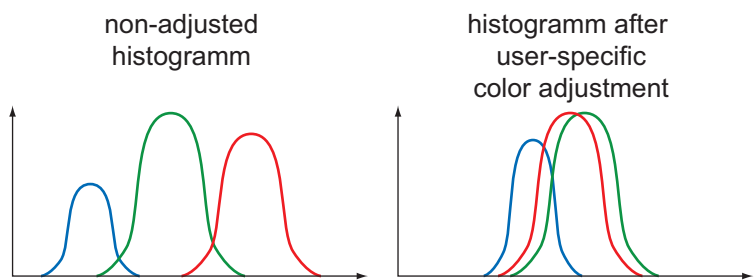

◀ **Figure 24**
Examples of histograms for a non-adjusted image and for an image after user-specific white balance..

8.2.2 One Push White Balance

Notice

Due to the internal processing of the camera, One Push White Balance refers to the current ROI but always considers the entire row.

Here, the three color spectrums are balanced to a single white point. The correction factors of the color gains are determined by the camera (one time).

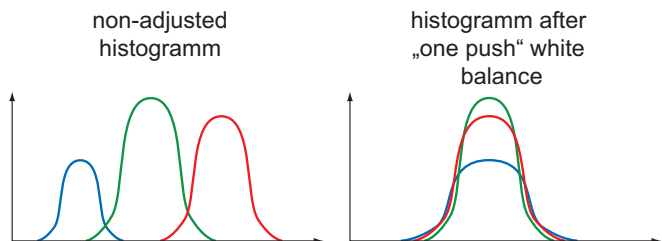

◀ **Figure 25**
Examples of histograms for a non-adjusted image and for an image after "one push" white balance.

8.3 Analog Controls

8.3.1 Offset / Black Level

On Baumer cameras, the offset (or black level) is adjustable from 0 to 255 LSB (always related to 12 bit).

8.3.2 Gain digital

In industrial environments motion blur is unacceptable. Due to this fact exposure times are limited. However, this causes low output signals from the camera and results in dark images. To solve this issue, the signals can be amplified by a user-defined gain factor within the camera. This gain factor is adjustable from 1.0 to 4.0.

Notice

Increasing the gain factor causes an increase of image noise and leads to missing codes at Mono12, if the gain factor > 1.0

8.4 Defect Pixel Correction

8.4.1 General information

A certain probability for abnormal pixels - the so-called defect pixels - applies to the sensors of all manufacturers. The charge quantity on these pixels is not linear-dependent on the exposure time.

The occurrence of these defect pixels is unavoidable and intrinsic to the manufacturing and aging process of the sensors.

The operation of the camera is not affected by these pixels. They only appear as brighter (warm pixel) or darker (cold pixel) spot in the recorded image.

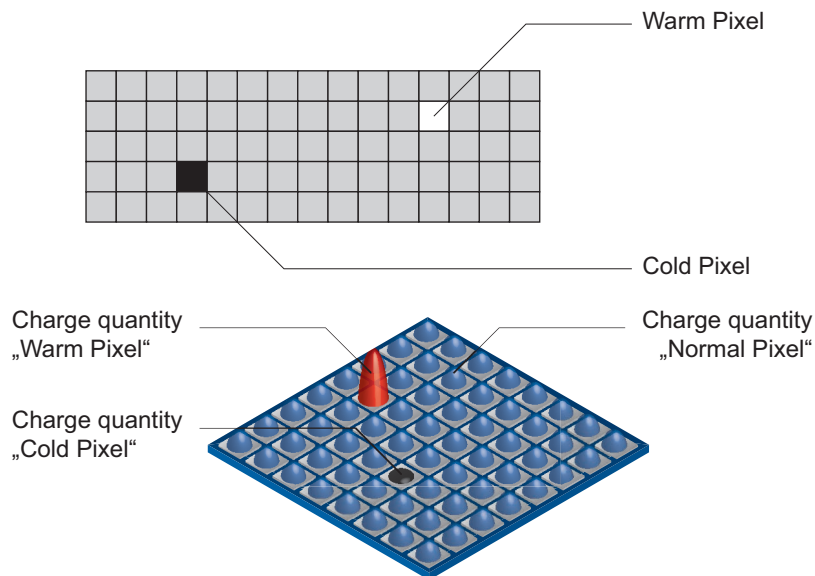

◀ **Figure 26**
Distinction of "hot" and "cold" pixels within the recorded image.

◀ **Figure 27**
Charge quantity of "hot" and "cold" pixels compared with "normal" pixels.

8.4.2 Correction Algorithm

On monochrome cameras of the Baumer SXC series, the problem of defect pixels is solved as follows:

- Possible defect pixels are identified during the production process of the camera.
- The coordinates of these pixels are stored in the factory settings of the camera.
- Once the sensor readout is completed, correction takes place:
 - Before any other processing, the values of the neighboring pixels on the left and the right side of the defect pixel, will be read out
 - Then the average value of these 2 pixels is determined
 - Finally, the value of the defect pixel is substituted by the previously determined average value

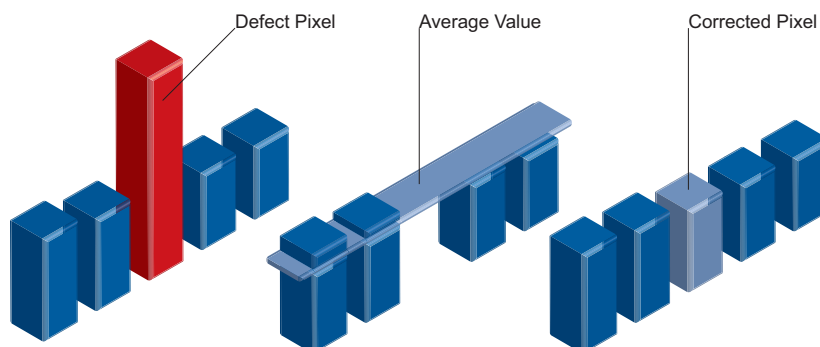

◀ **Figure 28**
Schematic diagram of the Baumer pixel correction.

8.4.3 Defectpixellist

As stated previously, this list is determined within the production process of Baumer cameras and stored in the factory settings. This list is editable.

8.5 Sequencer

8.5.1 General Information

A sequencer is used for the automated control of series of images using different sets of parameters.

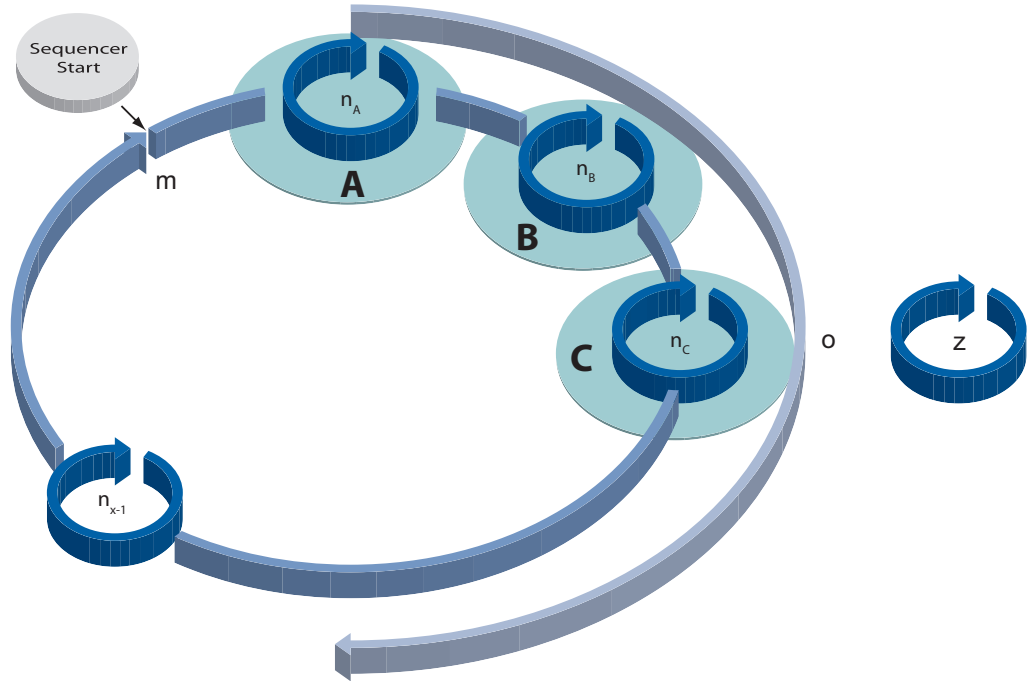

Figure 29 ▶

Flow chart of sequencer.

- m - number of sequence repetitions
- n - number of set repetitions
- o - number of sets of parameters
- z - number of frames per trigger

Sequencer Parameter:

The mentioned sets of parameter include the following:

- Exposure time
- Gain factor
- Repeat counter
- IO-Value

The figure above displays the fundamental structure of the sequencer module.

The loop counter (m) represents the number of sequence repetitions.

The repeat counter (n) is used to control the amount of images taken with the respective sets of parameters. For each set there is a separate n.

The start of the sequencer can be realized directly (free running) or via an external event (trigger). The source of the external event (trigger source) must be determined before.

The additional frame counter (z) is used to create a half-automated sequencer. It is absolutely independent from the other three counters, and used to determine the number of frames per external trigger event.

The following timeline displays the temporal course of a sequence with:

- n = (A=5), (B=3), (C=2) repetitions per set of parameters
- o = 3 sets of parameters (A,B and C)
- m = 1 sequence and
- z = 2 frames per trigger

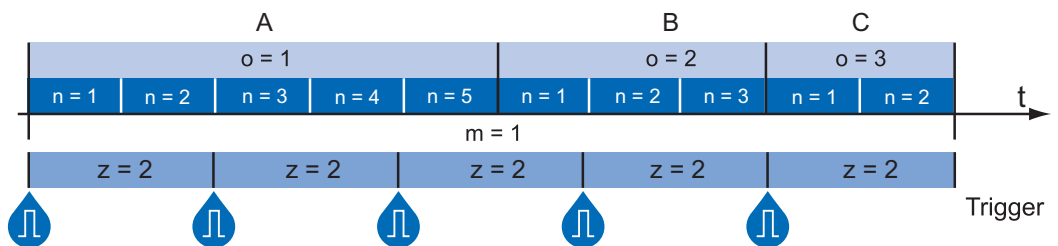
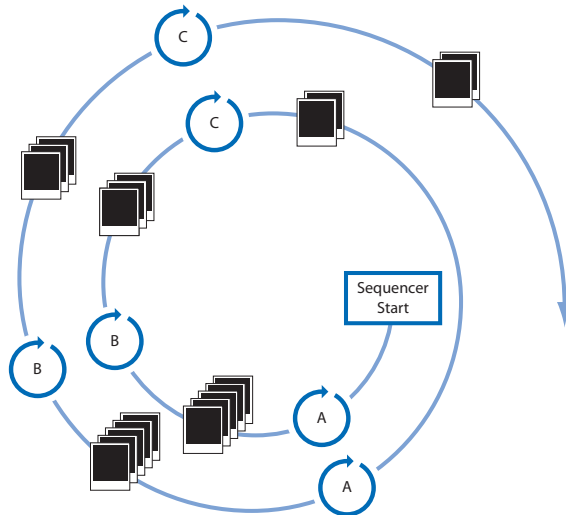

Figure 30 ▶

Timeline for a single sequence

8.5.2 Examples

8.5.2.1 Sequencer without Machine Cycle



◀ **Figure 31**

Example for a fully automated sequencer.

The figure above shows an example for a fully automated sequencer with three sets of parameters (A,B and C). Here the repeat counter (n) is set for (A=5), (B=3), (C=2) and the loop counter (m) has a value of 2.

When the sequencer is started, with or without an external event, the camera will record the pictures using the sets of parameters A, B and C (which constitutes a sequence).

After that, the sequence is started once again, followed by a stop of the sequencer - in this case the parameters are maintained.

8.5.2.2 Sequencer Controlled by Machine Steps (trigger)

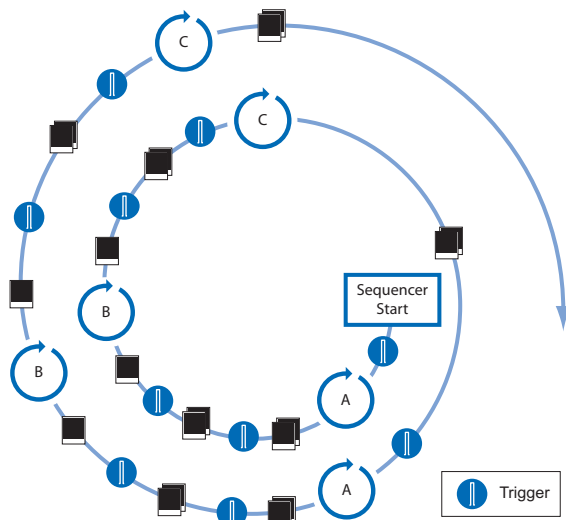

◀ **Figure 32**

Example for a half-automated sequencer.

The figure above shows an example for a half-automated sequencer with three sets of parameters (A,B and C) from the previous example. The frame counter (z) is set to 2. This means the camera records two pictures after an incoming trigger signal.

8.5.3 Capability Characteristics of Baumer-GAPI Sequencer Module

- up to 128 sets of parameters
- up to 4 billion loop passes
- up to 4 billion repetitions of sets of parameters
- up to 4 billion images per trigger event
- free running mode without initial trigger

Trigger Delay:
<i>The trigger delay is a flexible user-defined delay between the given trigger impulse and the image capture. The delay time can be set between 0.0 μsec and 2.0 sec with a stepsize of 1 μsec. In the case of multiple triggers during the delay the triggers will be stored and delayed, too. The buffer is able to store up to 512 trigger signals during the delay. Your benefits:</i>
<ul style="list-style-type: none"> ▪ No need for a perfect alignment of an external trigger sensor ▪ Different objects can be captured without hardware changes

8.5.4 Double Shutter

This feature offers the possibility of capturing two images in a very short interval. Depending on the application, this is performed in conjunction with a flash unit. Thereby the first exposure time (t_{exposure}) is arbitrary and accompanied by the first flash. The second exposure time must be equal to, or longer than the readout time (t_{readout}) of the sensor. Thus the pixels of the sensor are receptive again shortly after the first exposure. In order to realize the second short exposure time without an overrun of the sensor, a second short flash must be employed, and any subsequent extraneous light prevented.

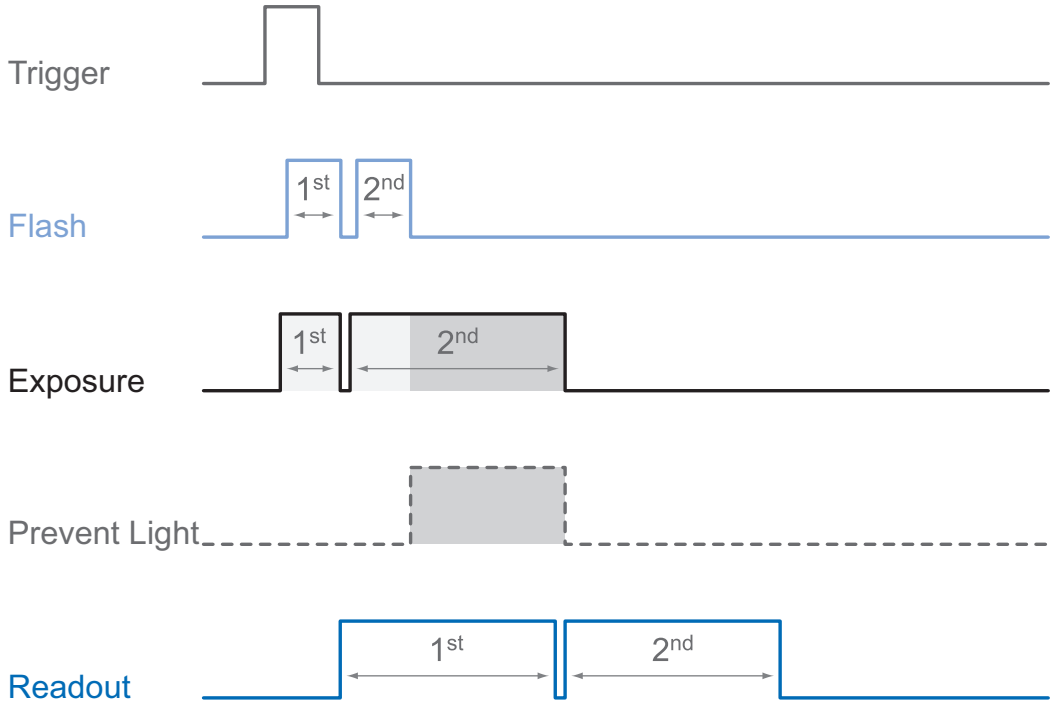

Figure 33 ▶
Example of a double shutter.

On Baumer TXG cameras this feature is realized within the sequencer.

In order to generate this sequence, the sequencer must be configured as follows:

Parameter	Setting:
Sequencer Run Mode	Once by Trigger
Sets of parameters (o)	2
Loops (m)	1
Repeats (n)	1
Frames Per Trigger (z)	2

8.6 Process Interface

8.6.1 Digital IOs

Cameras of the Baumer HXC series are equipped with three input lines and three output lines.

8.6.1.1 IO Circuits

Notice

Low Active: At this wiring, only one consumer can be connected. When all Output pins (1, 2, 3) connected to IO_GND, then current flows through the resistor as soon as one Output is switched. If only one output connected to IO_GND, then this one is only usable.

The other two Outputs are not usable and may not be connected (e.g. IO Power V_{CC})!

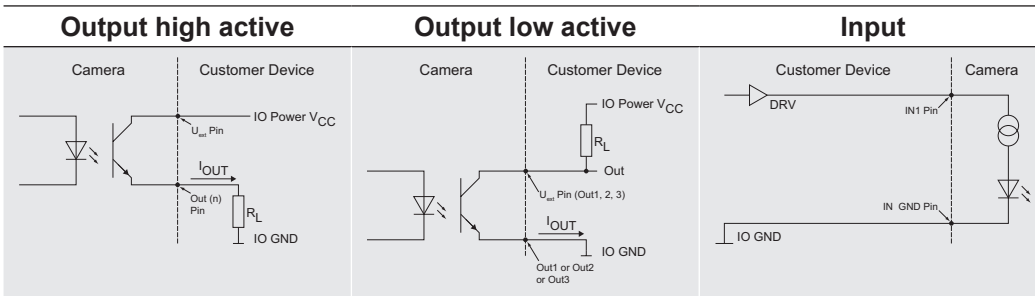

8.6.1.2 User Definable Inputs

The wiring of these input connectors is left to the user.

An exception is the compliance with predetermined high and low levels (0 .. 4.5V low, 11 .. 30V high).

The defined signals will have no direct effect, but can be analyzed and processed on the software side and used for controlling the camera.

The employment of a so called "IO matrix" offers the possibility of selecting the signal and the state to be processed.

On the software side the input signals are named "Line0", "Line1" and "Line2".

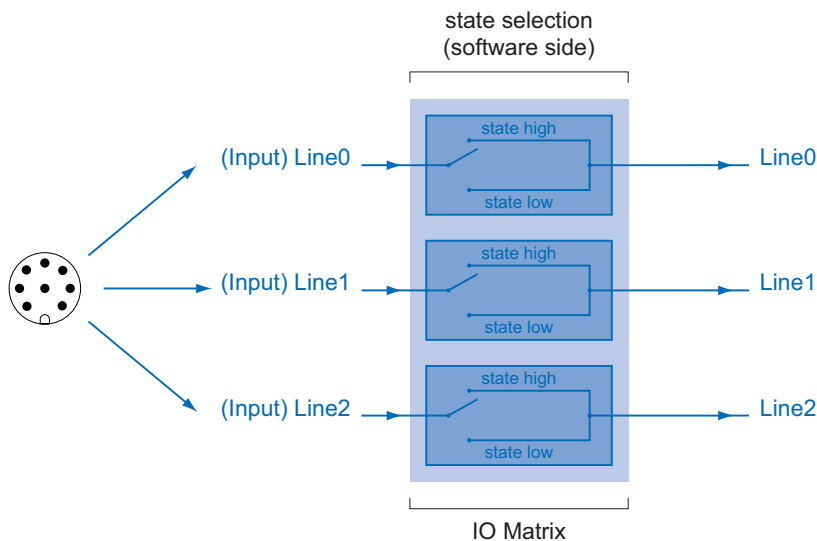

◀ **Figure 34**
IO matrix of the Baumer HXC on input side.

8.6.1.3 Configurable Outputs

With this feature, Baumer offers the possibility of wiring the output connectors to internal signals, which are controlled on the software side.

Hereby on cameras of the HXC series, 21 signal sources – subdivided into three categories – can be applied to the output connectors.

The first category of output signals represents a loop through of signals on the input side, such as:

Signal Name	Explanation
Line0	Signal of input "Line0" is loophroughed to this ouput
Line1	Signal of input "Line1" is loophroughed to this ouput
Line2	Signal of input "Line2" iys loophroughed to this ouput
FrameGrabberLine0	Signal of input "FrameGrabberLine0" is loophroughed to this ouput
FrameGrabberLine1	Signal of input "FrameGrabberLine1" is loophroughed to this ouput
FrameGrabberLine2	Signal of input "FrameGrabberLine2" is loophroughed to this ouput
FrameGrabberLine3	Signal of input "FrameGrabberLine3" is loophroughed to this ouput

Within the second category you will find signals that are created on camera side:

Signal Name	Explanation
FrameActive	The camera processes a Frame consisting of exposure and readout
TriggerReady	Camera is able to process an incoming trigger signal
TriggerOverlapped	The camera operates in overlapped mode
TriggerSkipped	Camera rejected an incoming trigger signal
ExposureActive	Sensor exposure in progress
TransferActive	Image transfer via hardware interface in progress

Beside the 13 signals mentioned above, each output can be wired to a user-defined signal ("UserOutput0", "UserOutput1", "UserOutput2", "SequencerOut 0...2", "SW-Trigger", "Exposure Start", "Exposure End", "Frame Start", "Frame End") or disabled ("OFF").

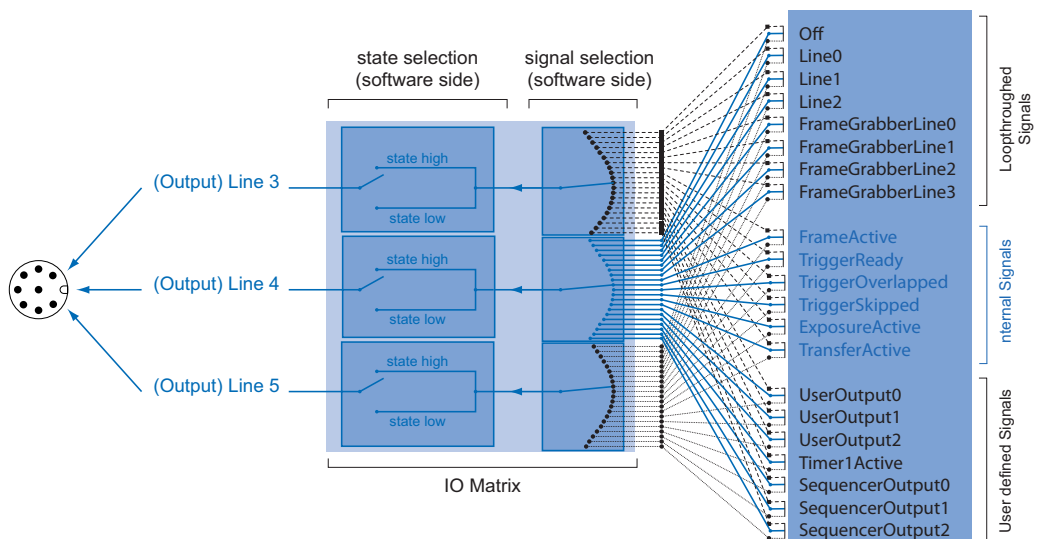

Figure 35 ▶

IO matrix of the Baumer HXC on output side.

8.6.2 Trigger Input / Trigger Delay

Trigger signals are used to synchronize the camera exposure and a machine cycle or, in case of a software trigger, to take images at predefined time intervals. Different trigger sources can be used:

Line0	FrameGrabberLine1
Line1	FrameGrabberLine2
Line2	FrameGrabberLine3
FrameGrabberLine0	SW-Trigger

There are three types of modes. The timing diagrams for the three types you can see below.

Normal Trigger with adjusted Exposure

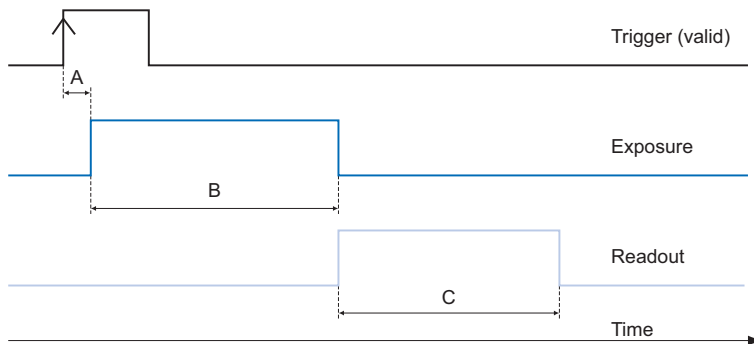

Pulse Width controlled Exposure

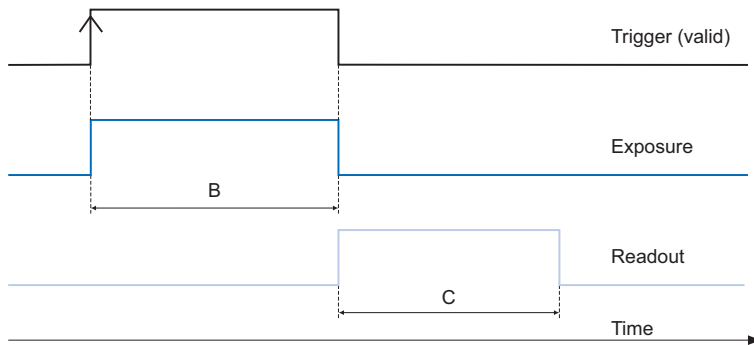

Edge controlled Exposure

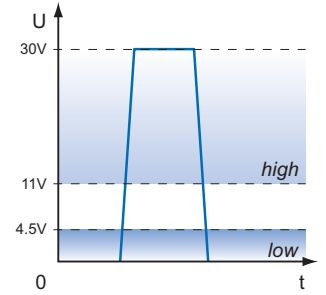
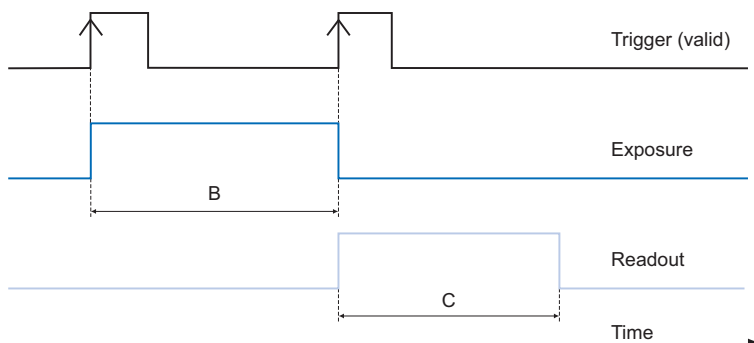

Figure 36 ▲

Trigger signal, valid for Baumer cameras.

Camera in trigger mode:

- A - Trigger delay
- B - Exposure time
- C - Readout time

8.6.3 Trigger Source

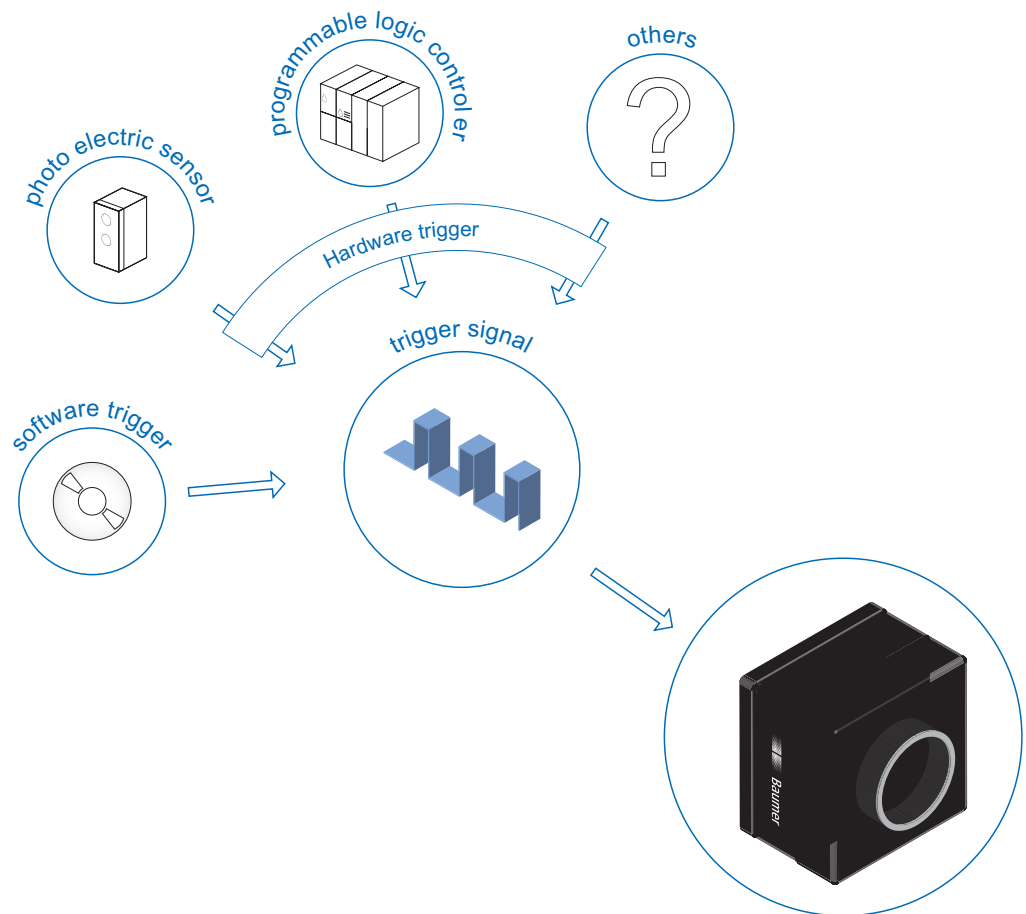

Figure 37 ▶

Examples of possible trigger sources.

Each trigger source has to be activated separately. When the trigger mode is activated, the hardware trigger is activated by default.

8.6.4 Debouncer

The basic idea behind this feature was to separate interfering signals (short peaks) from valid square wave signals, which can be important in industrial environments. Debouncing means that invalid signals are filtered out, and signals lasting longer than a user-defined testing time $t_{\text{DebounceHigh}}$ will be recognized, and routed to the camera to induce a trigger.

In order to detect the end of a valid signal and filter out possible jitters within the signal, a second testing time $t_{\text{DebounceLow}}$ was introduced. This timing is also adjustable by the user. If the signal value falls to state low and does not rise within $t_{\text{DebounceLow}}$, this is recognized as end of the signal.

The debouncing times $t_{\text{DebounceHigh}}$ and $t_{\text{DebounceLow}}$ are adjustable from 0 to 5 msec in steps of 1 μsec .

This feature is disabled by default.

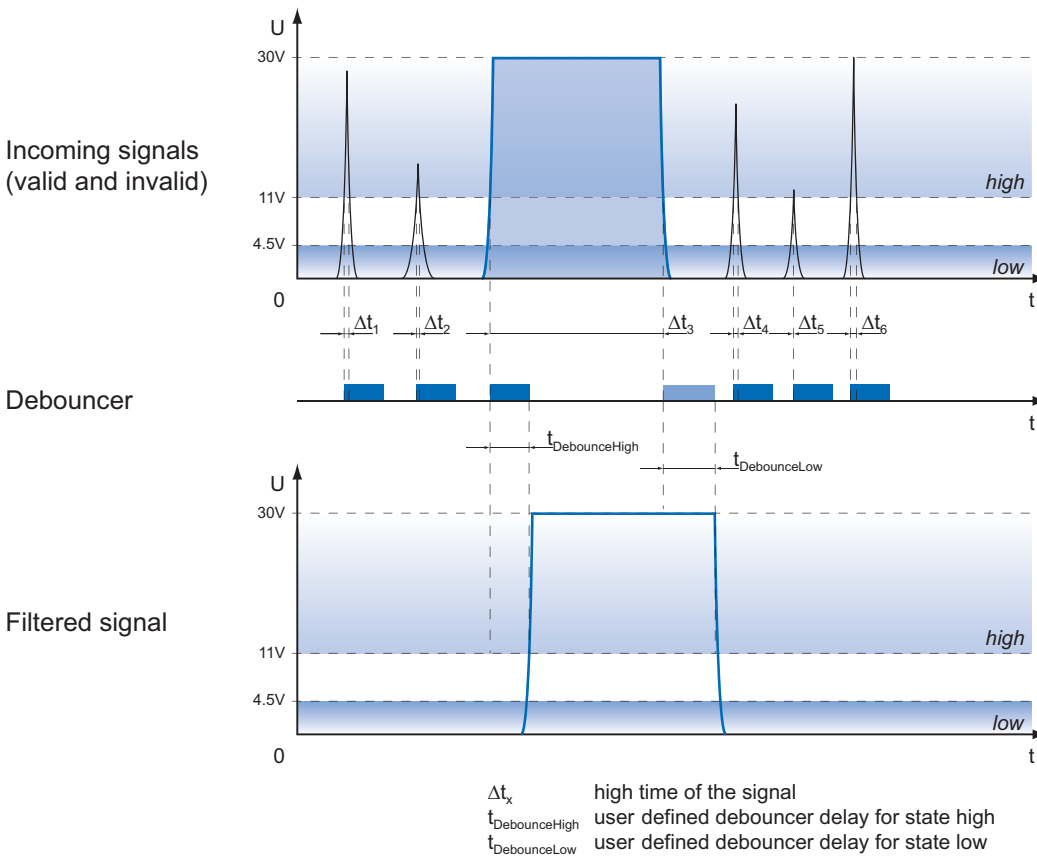

Debouncer:
 Please note that the edges of valid trigger signals are shifted by $t_{\text{DebounceHigh}}$ and $t_{\text{DebounceLow}}$. Depending on these two timings, the trigger signal might be temporally stretched or compressed.

◀ **Figure 38**
 Principle of the Baumer debouncer.

8.6.5 Flash Signal

On Baumer cameras, this feature is realized by the internal signal "ExposureActive", which can be wired to one of the digital outputs.

8.6.6 Timer

Timers were introduced for advanced control of internal camera signals.

On Baumer HXC cameras the timer configuration includes four components:

Setting	Description
TimerTriggerSource	This feature provides a source selection for each timer.
TimerTriggerActivation	This feature selects that part of the trigger signal (edges or states) that activates the timer.
TimerDelay	This feature represents the interval between incoming trigger signal and the start of the timer.
TimerDuration	By this feature the activation time of the timer is adjustable.

Different Timer sources can be used:

Line0	Exposure Start
Line1	Exposure End
Line2	Frame Start
TriggerSkipped	Frame End
SW-Trigger	

For example the using of a timer allows you to control the flash signal in that way, that the illumination does not start synchronized to the sensor exposure but a predefined interval earlier.

For this example you must set the following conditions:

Setting	Value
TriggerSource	InputLine0
TimerTriggerSource	InputLine0
Outputline7 (Source)	Timer1Active
TimerTriggerActivation	Falling Edge
Trigger Polarity	Falling Edge

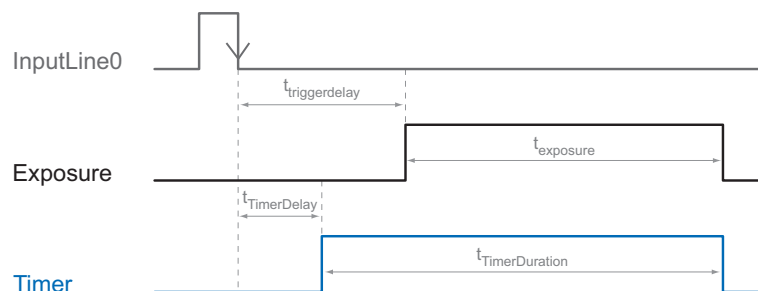

Figure 39 ▶

Possible Timer configuration on a Baumer HXC camera.

8.7 User Sets

Three user sets (1-3) are available for the Baumer cameras of the HXC series. The user sets can contain the following information:

Parameter	Parameter
Binning Mode	Mirroring Control
Camera Link® Control	Offset
Defectpixellist	Partial Scan
Digital I/O Settings	Pixelformat
Exposure Time	Readout Mode/Digitization Taps
Gain Factor	Testpattern
Look-Up-Table	Trigger Settings
Shutter Mode	Fixed Frame rate
Color Gains	Gamma
Speed Mode	IO-Settings

These user sets are stored within the camera and cannot be saved outside the device.

By employing a so-called "user set default selector", one of the three possible user sets can be selected as default, which means, the camera starts up with these adjusted parameters.

8.8 Factory Settings

The factory settings are stored in an additional parametrization set which is used by default. This settings are not editable.

9. Camera Link® Interface

The Camera Link® interface was specifically developed for cameras in machine vision applications and provides high transfer rates and low latency. Depending on the configuration (Base, Medium or Full) the transfer rate adds up to 800 MBytes/sec.

Cameras of the Baumer HXC series are equipped with a Camera Link® Full interface and therewith able to transmit up to 800 MBytes/sec.

9.1 Channel Link and LVDS Technology

Camera Link® bases upon the Channel Link® technology, but provides a specification, that is more beneficial for machine vision.

Channel Link® in turn is an advancement of the LDVS (Low Voltage Differential Signaling) standard – a low power, high speed interface standard.

The Channel Link® technology consists of a transmitter receiver pair with 21, 28 or 48 single-ended data signals and a single-ended clock signal can be wired on transmitter side. Within the transmitter the data is serialized with a ratio of 7:1. Afterwards the four resulting data streams and the clock signal are transferred via five LVDS pairs. On receiver side the four LVDS data streams and the LVDS clock are reordered to parallel signals and afterwards forwarded to further processing.

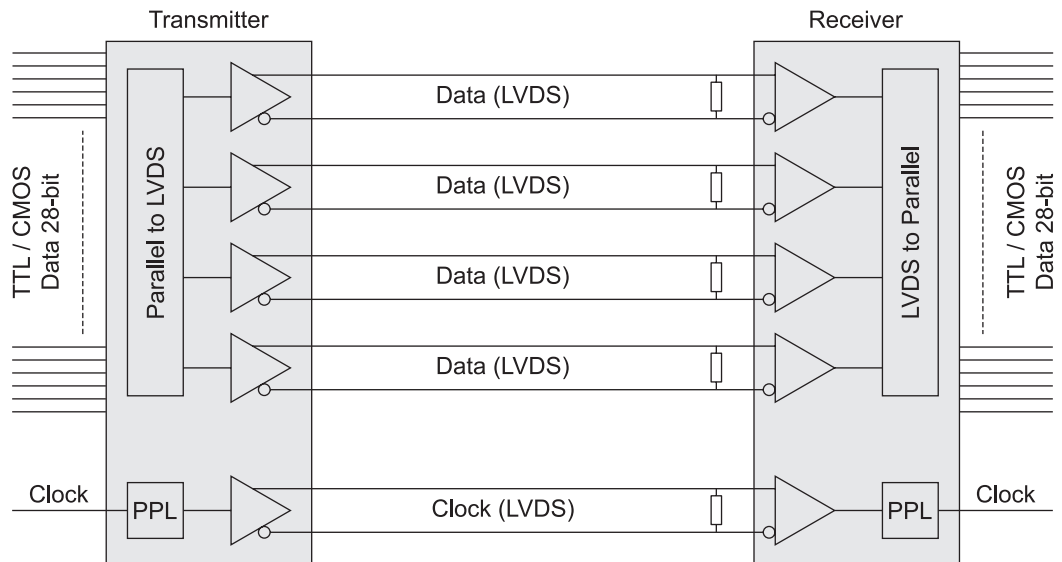

Figure 40 ►
Channel Link® operation.

9.2 Camera Signals

The standard designates three different signal types, provided via standard Camera Link® cable:

9.2.1 Serial Communication

The standard regulates two LVDS pairs are allocated for asynchronous serial communication between the camera and the frame grabber. Cameras and frame grabbers should support at least 9600 baud serial communication.

The following signals are designated:

Signal	Description
SerTFG	LVDS pair for serial communications to the frame grabber
SerTC	LVDS pair for serial communications to the camera

The serial interface must apply the following regulations:

- one start bit,
- one stop bit,
- no parity and
- no handshaking.

9.2.2 Camera Control

According to the Camera Link® standard four LVDS pairs have to be reserved for general-purpose camera control. They are defined as frame grabber outputs and camera inputs. The definition of these signals is left to the camera manufacturer.

Signal	Baumer Naming	Employment
Camera Control 1 (CC1)	FrameGrabberLine0	On Baumer HXC cameras, the wiring of these signals is arbitrary.
Camera Control 2 (CC2)	FrameGrabberLine1	
Camera Control 3 (CC3)	FrameGrabberLine2	
Camera Control 4 (CC4)	FrameGrabberLine3	

9.2.3 Video Data

The standard designates four signals (as well as the signal state) for the validation of transmitted image data:

Signal	Description
FVAL	Frame Valid is defined high for valid lines.
LVAL	Line Valid is defined high for valid pixels.
DVAL	Data Valid is defined high for valid data.
Spare	Has been defined for future use.

9.3 Camera Link® Taps

The standard defines a tap as "the data path carrying a stream of pixels". This means the number of taps equates to the number of simultaneously transferred pixel.

Notice

Please do not mix up sensor digitization taps and Camera Link® taps!

9.3.1 Tap Configuration

Within the subsequent sections, the transmission of images with different pixel formats (bit depth) linked to the employment of different numbers of taps is displayed.

Configuration	Cables
CL Base (1T8, 2T8, 3T8, 1T10, 2T10, 1T12, 2T12)	1
CL Medium (3T10, 3T12, 4T8, 4T10 4T12)	2
CL Full (8T8)	2
CL Deca (10T8)	2

9.3.1.1 CL Base 8-bit Monochrome Single Tap Transmission (1T8)

Port A	Tap 1 bit 0	Tap 1 bit 1	Tap 1 bit 2	Tap 1 bit 3	Tap 1 bit 4	Tap 1 bit 5	Tap 1 bit 6	Tap 1 bit 7
Port B								
Port C								

9.3.1.2 CL Base 8-bit Monochrome Dual Tap Transmission (2T8)

Port A	Tap 1 bit 0	Tap 1 bit 1	Tap 1 bit 2	Tap 1 bit 3	Tap 1 bit 4	Tap 1 bit 5	Tap 1 bit 6	Tap 1 bit 7
Port B	Tap 2 bit 0	Tap 2 bit 1	Tap 2 bit 2	Tap 2 bit 3	Tap 2 bit 4	Tap 2 bit 5	Tap 2 bit 6	Tap 2 bit 7
Port C								

9.3.1.3 CL Base 8-bit Monochrome Triple Tap Transmission (3T8)

Port A	Tap 1 bit 0	Tap 1 bit 1	Tap 1 bit 2	Tap 1 bit 3	Tap 1 bit 4	Tap 1 bit 5	Tap 1 bit 6	Tap 1 bit 7
Port B	Tap 2 bit 0	Tap 2 bit 1	Tap 2 bit 2	Tap 2 bit 3	Tap 2 bit 4	Tap 2 bit 5	Tap 2 bit 6	Tap 2 bit 7
Port C	Tap 3 bit 0	Tap 3 bit 1	Tap 3 bit 2	Tap 3 bit 3	Tap 3 bit 4	Tap 3 bit 5	Tap 3 bit 6	Tap 3 bit 7

9.3.1.4 CL Base 10-bit Monochrome Single Tap Transmission (1T10)

Port A	Tap 1 bit 0	Tap 1 bit 1	Tap 1 bit 2	Tap 1 bit 3	Tap 1 bit 4	Tap 1 bit 5	Tap 1 bit 6	Tap 1 bit 7
Port B	Tap 1 bit 8	Tap 1 bit 9						
Port C								

9.3.1.5 CL Base 10-bit Monochrome Dual Tap Transmission (2T10)

Port A	Tap 1 bit 0	Tap 1 bit 1	Tap 1 bit 2	Tap 1 bit 3	Tap 1 bit 4	Tap 1 bit 5	Tap 1 bit 6	Tap 1 bit 7
Port B	Tap 1 bit 8	Tap 1 bit 9			Tap 2 bit 8	Tap 2 bit 9		
Port C	Tap 2 bit 0	Tap 2 bit 1	Tap 2 bit 2	Tap 2 bit 3	Tap 2 bit 4	Tap 2 bit 5	Tap 2 bit 6	Tap 2 bit 7

9.3.1.6 CL Base 12-bit Monochrome Single Tap Transmission (1T12)

Port A	Tap 1 bit 0	Tap 1 bit 1	Tap 1 bit 2	Tap 1 bit 3	Tap 1 bit 4	Tap 1 bit 5	Tap 1 bit 6	Tap 1 bit 7
Port B	Tap 1 bit 8	Tap 1 bit 9	Tap 1 bit 10	Tap 1 bit 11				
Port C								

9.3.1.7 CL Base 12-bit Monochrome Dual Tap Transmission (2T12)

Port A	Tap 1 bit 0	Tap 1 bit 1	Tap 1 bit 2	Tap 1 bit 3	Tap 1 bit 4	Tap 1 bit 5	Tap 1 bit 6	Tap 1 bit 7
Port B	Tap 1 bit 8	Tap 1 bit 9	Tap 1 bit 10	Tap 1 bit 11	Tap 2 bit 8	Tap 2 bit 9	Tap 2 bit 10	Tap 2 bit 11
Port C	Tap 2 bit 0	Tap 2 bit 1	Tap 2 bit 2	Tap 2 bit 3	Tap 2 bit 4	Tap 2 bit 5	Tap 2 bit 6	Tap 2 bit 7

9.3.1.8 CL Medium 10-bit Monochrome Triple Tap Transmission (3T10)

Port A	Tap 1 bit 0	Tap 1 bit 1	Tap 1 bit 2	Tap 1 bit 3	Tap 1 bit 4	Tap 1 bit 5	Tap 1 bit 6	Tap 1 bit 7
Port B	Tap 1 bit 8	Tap 1 bit 9			Tap 2 bit 8	Tap 2 bit 9		
Port C	Tap 2 bit 0	Tap 2 bit 1	Tap 2 bit 2	Tap 2 bit 3	Tap 2 bit 4	Tap 2 bit 5	Tap 2 bit 6	Tap 2 bit 7
Port D								
Port E	Tap 3 bit 0	Tap 3 bit 1	Tap 3 bit 2	Tap 3 bit 3	Tap 3 bit 4	Tap 3 bit 5	Tap 3 bit 6	Tap 3 bit 7
Port F	Tap 3 bit 8	Tap 3 bit 9						

9.3.1.9 CL Medium 12-bit Monochrome Triple Tap Transmission (3T12)

Port A	Tap 1 bit 0	Tap 1 bit 1	Tap 1 bit 2	Tap 1 bit 3	Tap 1 bit 4	Tap 1 bit 5	Tap 1 bit 6	Tap 1 bit 7
Port B	Tap 1 bit 0	Tap 1 bit 1	Tap 1 bit 2	Tap 1 bit 3	Tap 2 bit 8	Tap 2 bit 9	Tap 2 bit 10	Tap 2 bit 11
Port C	Tap 2 bit 0	Tap 2 bit 1	Tap 2 bit 2	Tap 2 bit 3	Tap 2 bit 4	Tap 2 bit 5	Tap 2 bit 6	Tap 2 bit 7
Port D								
Port E	Tap 3 bit 0	Tap 3 bit 1	Tap 3 bit 2	Tap 3 bit 3	Tap 3 bit 4	Tap 3 bit 5	Tap 3 bit 6	Tap 3 bit 7
Port F	Tap 3 bit 0	Tap 3 bit 1	Tap 3 bit 2	Tap 3 bit 3				

9.3.1.10 CL Medium 8-bit Monochrome Quad Tap Transmission (4T8)

Port A	Tap 1 bit 0	Tap 1 bit 1	Tap 1 bit 2	Tap 1 bit 3	Tap 1 bit 4	Tap 1 bit 5	Tap 1 bit 6	Tap 1 bit 7
Port B	Tap 2 bit 0	Tap 2 bit 1	Tap 2 bit 2	Tap 2 bit 3	Tap 2 bit 4	Tap 2 bit 5	Tap 2 bit 6	Tap 2 bit 7
Port C	Tap 3 bit 0	Tap 3 bit 1	Tap 3 bit 2	Tap 3 bit 3	Tap 3 bit 4	Tap 3 bit 5	Tap 3 bit 6	Tap 3 bit 7
Port D	Tap 4 bit 0	Tap 4 bit 1	Tap 4 bit 2	Tap 4 bit 3	Tap 4 bit 4	Tap 4 bit 5	Tap 4 bit 6	Tap 4 bit 7

9.3.1.11 CL Medium 10-bit Monochrome Quad Tap Transmission (4T10)

Port A	Tap 1 bit 0	Tap 1 bit 1	Tap 1 bit 2	Tap 1 bit 3	Tap 1 bit 4	Tap 1 bit 5	Tap 1 bit 6	Tap 1 bit 7
Port B	Tap 1 bit 8	Tap 1 bit 9			Tap 2 bit 8	Tap 2 bit 9		
Port C	Tap 2 bit 0	Tap 2 bit 1	Tap 2 bit 2	Tap 2 bit 3	Tap 2 bit 4	Tap 2 bit 5	Tap 2 bit 6	Tap 2 bit 7
Port D	Tap 4 bit 0	Tap 4 bit 1	Tap 4 bit 2	Tap 4 bit 3	Tap 4 bit 4	Tap 4 bit 5	Tap 4 bit 6	Tap 4 bit 7
Port E	Tap 3 bit 0	Tap 3 bit 1	Tap 3 bit 2	Tap 3 bit 3	Tap 3 bit 4	Tap 3 bit 5	Tap 3 bit 6	Tap 3 bit 7
Port F	Tap 3 bit 8	Tap 3 bit 9			Tap 4 bit 8	Tap 4 bit 9		

9.3.1.12 CL Medium 12-bit Monochrome Quad Tap Transmission (4T12)

Port A	Tap 1 bit 0	Tap 1 bit 1	Tap 1 bit 2	Tap 1 bit 3	Tap 1 bit 4	Tap 1 bit 5	Tap 1 bit 6	Tap 1 bit 7
Port B	Tap 1 bit 8	Tap 1 bit 9	Tap 1 bit 10	Tap 1 bit 11	Tap 2 bit 8	Tap 2 bit 9	Tap 2 bit 10	Tap 2 bit 11
Port C	Tap 2 bit 0	Tap 2 bit 1	Tap 2 bit 2	Tap 2 bit 3	Tap 2 bit 4	Tap 2 bit 5	Tap 2 bit 6	Tap 2 bit 7
Port D	Tap 4 bit 0	Tap 4 bit 1	Tap 4 bit 2	Tap 4 bit 3	Tap 4 bit 4	Tap 4 bit 5	Tap 4 bit 6	Tap 4 bit 7
Port E	Tap 3 bit 0	Tap 3 bit 1	Tap 3 bit 2	Tap 3 bit 3	Tap 3 bit 4	Tap 3 bit 5	Tap 3 bit 6	Tap 3 bit 7
Port F	Tap 3 bit 8	Tap 3 bit 9	Tap 3 bit 10	Tap 3 bit 11	Tap 4 bit 8	Tap 4 bit 9	Tap 4 bit 10	Tap 4 bit 11

9.3.1.13 CL Full 8-bit Monochrome Eight Tap Transmission (8T8)

Port A	Tap 1 bit 0	Tap 1 bit 1	Tap 1 bit 2	Tap 1 bit 3	Tap 1 bit 4	Tap 1 bit 5	Tap 1 bit 6	Tap 1 bit 7
Port B	Tap 2 bit 0	Tap 2 bit 1	Tap 2 bit 2	Tap 2 bit 3	Tap 2 bit 4	Tap 2 bit 5	Tap 2 bit 6	Tap 2 bit 7
Port C	Tap 3 bit 0	Tap 3 bit 1	Tap 3 bit 2	Tap 3 bit 3	Tap 3 bit 4	Tap 3 bit 5	Tap 3 bit 6	Tap 3 bit 7
Port D	Tap 4 bit 0	Tap 4 bit 1	Tap 4 bit 2	Tap 4 bit 3	Tap 4 bit 4	Tap 4 bit 5	Tap 4 bit 6	Tap 4 bit 7
Port E	Tap 5 bit 0	Tap 5 bit 1	Tap 5 bit 2	Tap 5 bit 3	Tap 5 bit 4	Tap 5 bit 5	Tap 5 bit 6	Tap 5 bit 7
Port F	Tap 6 bit 0	Tap 6 bit 1	Tap 6 bit 2	Tap 6 bit 3	Tap 6 bit 4	Tap 6 bit 5	Tap 6 bit 6	Tap 6 bit 7
Port G	Tap 7 bit 0	Tap 7 bit 1	Tap 7 bit 2	Tap 7 bit 3	Tap 7 bit 4	Tap 7 bit 5	Tap 7 bit 6	Tap 7 bit 7
Port H	Tap 8 bit 0	Tap 8 bit 1	Tap 8 bit 2	Tap 8 bit 3	Tap 8 bit 4	Tap 8 bit 5	Tap 8 bit 6	Tap 8 bit 7

9.3.1.14 CL Deca 8-bit Monochrome Ten Tap Transmission (10T8)

Port A	Tap 1 bit 0	Tap 1 bit 1	Tap 1 bit 2	Tap 1 bit 3	Tap 1 bit 4	Tap 1 bit 5	Tap 1 bit 6	Tap 1 bit 7
Port B	Tap 2 bit 0	Tap 2 bit 1	Tap 2 bit 2	Tap 2 bit 3	Tap 2 bit 4	Tap 2 bit 5	Tap 2 bit 6	Tap 2 bit 7
Port C	Tap 3 bit 0	Tap 3 bit 1	Tap 3 bit 2	Tap 3 bit 3	Tap 3 bit 4	Tap 3 bit 5	Tap 3 bit 6	Tap 3 bit 7
Port D	Tap 4 bit 0	Tap 4 bit 1	Tap 4 bit 2	Tap 4 bit 3	Tap 4 bit 4	Tap 4 bit 5	Tap 4 bit 6	Tap 4 bit 7
Port E	Tap 5 bit 0	Tap 5 bit 1	Tap 5 bit 2	Tap 5 bit 3	Tap 5 bit 4	Tap 5 bit 5	Tap 5 bit 6	Tap 5 bit 7
Port F	Tap 6 bit 0	Tap 6 bit 1	Tap 6 bit 2	Tap 6 bit 3	Tap 6 bit 4	Tap 6 bit 5	Tap 6 bit 6	Tap 6 bit 7
Port G	Tap 7 bit 0	Tap 7 bit 1	Tap 7 bit 2	Tap 7 bit 3	Tap 7 bit 4	Tap 7 bit 5	Tap 7 bit 6	Tap 7 bit 7
Port H	Tap 8 bit 0	Tap 8 bit 1	Tap 8 bit 2	Tap 8 bit 3	Tap 8 bit 4	Tap 8 bit 5	Tap 8 bit 6	Tap 8 bit 7
Port I	Tap 9 bit 0	Tap 9 bit 1	Tap 9 bit 2	Tap 9 bit 3	Tap 9 bit 4	Tap 9 bit 5	Tap 9 bit 6	Tap 9 bit 7
Port J	Tap 10 bit 0	Tap 10 bit 1	Tap 10 bit 2	Tap 10 bit 3	Tap 10 bit 4	Tap 10 bit 5	Tap 10 bit 6	Tap 10 bit 7

9.3.2 Tap Geometry

Since frame grabbers possess the ability of image reconstruction from multi-tap cameras "on-the-fly", the Camera Link® standards demands the specification of the used / supported tap geometries from the manufacturers of both, cameras and frame grabbers.

9.3.2.1 Single Tap Geometry

For single tap transmission the cameras of the Baumer HXC series employ the 1X-1Y tap geometry:

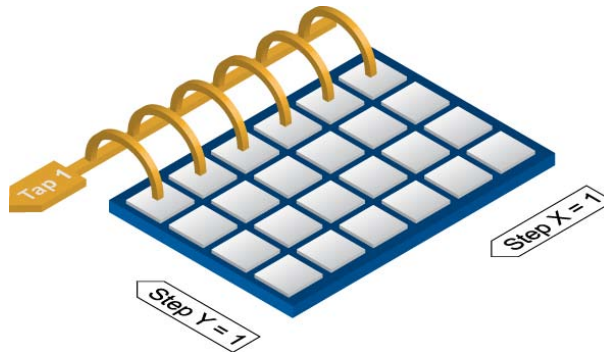

Figure 41 ▶

Tap geometry 1X-1Y.
The pixel information is transmitted pixel-by-pixel and line-by-line.

9.3.2.2 Dual Tap Geometry

For dual tap transmission the cameras of the Baumer HXC series employ the 1X2-1Y tap geometry:

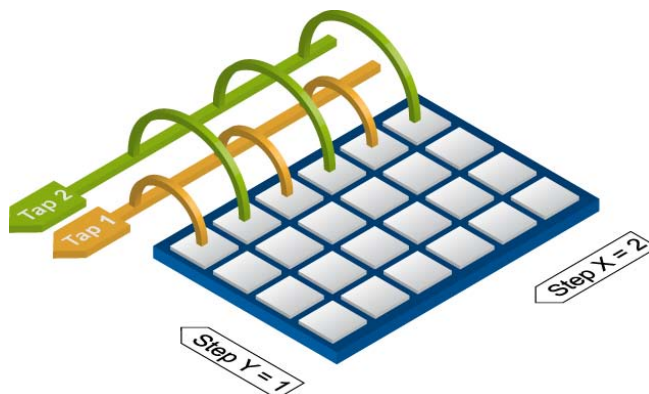

Figure 42 ▶

Tap geometry 1X2-1Y.

9.3.2.3 Triple Tap Geometry

For triple tap transmission the cameras of the Baumer HXC series employ the 1X3-1Y tap geometry:

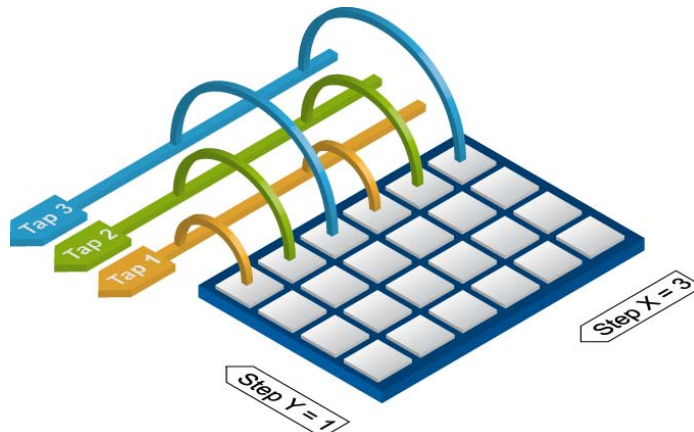
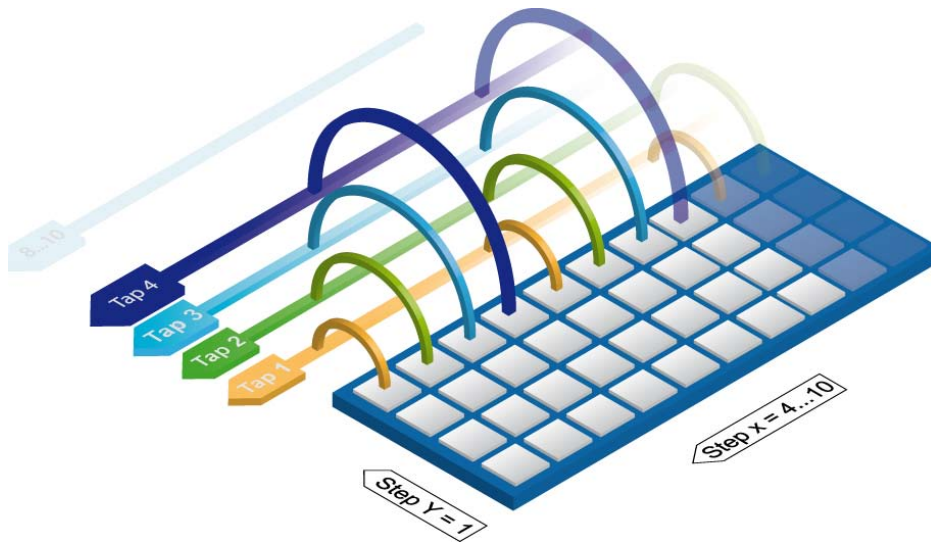

Figure 43 ▶

Tap geometry 1X3-1Y.

9.3.2.4 Quad, Eight and Ten Tap Geometry

For Quad, Eight and Ten tap transmission the cameras of the Baumer HXC series use the same system.



◀ **Figure 44**
Tap geometry 1X4...10-
1Y.

10. Lens install

Notice

Avoid contamination of the sensor and the lens by dust and airborne particles when mounting a lens to the device!

Therefore the following points are very important:

- Install lenses in an environment that is as dust free as possible!
- Keep the dust covers on camera and lens as long as possible!
- Hold the camera downwards with unprotected sensor (or filter- /cover glass)!
- Avoid contact with any optical surface of the camera or lens!

At the example on the figures below the installation of C-mount objective is shown. At a camera with F-Mount it is principle the same.

1. Turn the camera with the lens mount to the bottom.

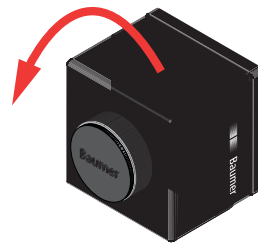

2. Unscrew the protective cap.

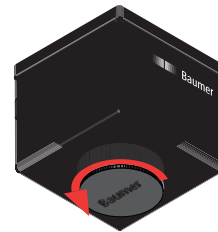

3. Screw the lens on the lens mount.



11. Cleaning

Cover glass

Notice

The sensor is mounted dust-proof. Remove of the cover glass for cleaning is not necessary.

Avoid cleaning the cover glass of the CCD sensor if possible. To prevent dust, follow the instructions under "Install lens".

If you must clean it, use compressed air or a soft, lint free cloth dampened with a small quantity of pure alcohol.

Housing



Caution!



Volatile solvents for cleaning.

Volatile solvents damage the surface of the camera.

Never use volatile solvents (benzine, thinner) for cleaning!

To clean the surface of the camera housing, use a soft, dry cloth. To remove persistent stains, use a soft cloth dampened with a small quantity of neutral detergent, then wipe dry.

12. Transport / Storage

Notice

Transport the camera only in the original packaging. When the camera is not installed, then storage the camera in original packaging.

Storage Environment

Storage temperature	-10°C ... +70°C (+14°F ... +158°F)
Storage Humidity	10% ... 90% non condensing

13. Disposal



Dispose of outdated products with electrical or electronic circuits, not in the normal domestic waste, but rather according to your national law and the directives 2002/96/EC and 2006/66/EC for recycling within the competent collectors.

Through the proper disposal of obsolete equipment will help to save valuable resources and prevent possible adverse effects on human health and the environment.

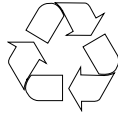

The return of the packaging to the material cycle helps conserve raw materials and reduces the production of waste. When no longer required, dispose of the packaging materials in accordance with the local regulations in force.

Keep the original packaging during the warranty period in order to be able to pack the device properly in the event of a warranty claim.

14. Warranty Information

Notice

There are no adjustable parts inside the camera!

In order to avoid the loss of warranty do not open the housing!

Notice

If it is obvious that the device is / was dismantled, reworked or repaired by other than Baumer technicians, Baumer Optronic will not take any responsibility for the subsequent performance and quality of the device!

15. Conformity



Cameras of the Baumer HXC family comply with:

- CE,
- FCC Part 15 Class B,
- RoHS

15.1 CE

We declare, under our sole responsibility, that the previously described Baumer HXC cameras conform with the directives of the CE.

15.2 FCC – Class B Device

NOTE: This equipment has been tested and found to comply with the limits for a Class B digital device, pursuant to part 15 of the FCC Rules. These limits are designed to provide reasonable protection against harmful interference in a residential environment.

This equipment generates, uses, and can radiate radio frequency energy and, if not installed and used in accordance with the instructions, may cause harmful interference to radio communications. However, there is no guarantee that interference will not occur in a particular installation.

If this equipment does cause harmful interference to radio or television reception, which can be determined by turning the equipment off and on, the user is encouraged to try to correct the interference by one or more of the following measures:

- Reorient or relocate the receiving antenna.
- Increase the separation between the equipment and the receiver.
- Connect the equipment into an outlet on a circuit different from that to which the receiver is connected.
- Consult the dealer or an experienced radio/TV technician for help.



